



# Equestrian Sport Rules



**TABLE OF CONTENTS**

**1. GOVERNING RULES ..... 5**

**2. OFFICIAL EVENTS..... 5**

    2.1 English Style Events ..... 5

    2.2 Western Style Events ..... 5

**3. RULES OF COMPETITION ..... 6**

    3.1 Athletes ..... 6

    3.2 Training Sessions..... 6

    3.3 Entries Deadline ..... 6

    3.4 Assistance Dogs ..... 6

    3.5 Safety Inspection ..... 6

    3.6 Broken Equipment..... 6

    3.7 Spotters ..... 6

    3.8 Outside Assistance Penalization ..... 6

    3.9 Visual Aid Policy ..... 6

    3.10 Task Translations ..... 6

    3.11 World Games Horses Provision ..... 6

    3.12 Horse Suitability ..... 6

    3.13 Coggins Test ..... 6

    3.14 Horse Rules ..... 6

    3.15 Multiple Competitors and Horses ..... 6

    3.16 Sedatives ..... 6

    3.17 Change of Horse ..... 6

    3.18 Veterinarian’s Decision ..... 6

    3.19 Unsoundness..... 6

    3.20 Grievances ..... 6

**4. ATTIRE ..... 6**

    4.1 Clothing. .... 6

    4.2 Boots ..... 6

    4.3 Helmets..... 7

    4.4 Number. .... 7

    4.5 Practice Attire..... 7

    4.6 Additional ..... 7

**5. TACK ..... 7**

    5.1 Saddles ..... 7

    5.2 Athlete Saddle ..... 7

    5.3 Adapted and personally owned saddles. .... 7

    5.4 Bridles ..... 7

    5.5 Halters..... 7

    5.6 Adaptive Equipment ..... 7

    5.7 Prohibited Tack and Equipment ..... 7

    5.8 Additional Guidelines..... 7

**6. JUDGING ..... 7**



6.1 Points Consideration.....	7
6.2 Results.....	7
6.3 Unauthorized Assistance.....	7
6.4 Additional Guidelines.....	8
<b>7. HOSTING A COMPETITION.....</b>	<b>8</b>
7.1 Facility and Equipment Requirements.....	8
7.2 Invitations and Entries.....	8
7.3 Head Coaches' Meeting.....	8
7.4 Matching Horses.....	8
7.5 Practicing.....	9
<b>8. DIVISIONING.....</b>	<b>9</b>
8.1 Ability Based.....	9
8.2 Definitions.....	9
8.3 Division Levels.....	9
<b>9. ENGLISH STYLE EVENTS.....</b>	<b>10</b>
<b>10. DRESSAGE.....</b>	<b>10</b>
10.1General Information (Dressage and Prix Caprilli).....	10
10.2Facilities and Set-up.....	11
10.3Judging.....	11
10.4Gaits.....	13
10.5Position and Aids of the Rider.....	13
10.6Execution of Dressage Tests.....	13
10.7Dressage Tests.....	14
<b>11. PRIX CAPRILLI.....</b>	<b>19</b>
11.1General Information (Refer to the Dressage section).....	19
11.2Facilities and Set-up.....	19
11.3Judging.....	20
11.4Prix Caprilli Tests.....	22
<b>12. EQUITATION JUMPING.....</b>	<b>24</b>
12.1Definition.....	24
12.2Levels of Competition.....	24
12.3Rules of competition.....	24
12.4Facilities and Set-up.....	24
12.5Judging.....	24
12.6Errors of position.....	25
<b>13. ENGLISH EQUITATION.....</b>	<b>27</b>
13.1General Information.....	27
13.2Class Routines and Expectations.....	27
13.3English Equitation Tests.....	27
<b>14. ENGLISH WORKING TRAILS.....</b>	<b>32</b>
14.1General Information.....	32
14.2Judging.....	33
14.3English Trail Elements.....	33



**15. WESTERN EVENTS SECTION .....36**  
  15.1 Stock Seat Equitation ..... 36  
  15.2 Western Riding ..... 37

**16. WESTERN WORKING TRAILS .....42**  
  16.1 General Information ..... 42  
  16.2 Judging ..... 42  
  16.3 Western Trail Elements ..... 43

**17. ENGLISH AND WESTERN EVENTS: Section B: Showmanship .....49**  
  17.1 General Information ..... 49  
  17.2 Class Routine ..... 50  
  17.3 Judging ..... 51  
  17.4 Faults ..... 52

**18. ENGLISH AND WESTERN EVENTS: GYMKHANA .....52**  
  18.1 General Information ..... 52  
  18.2 Pole Bending ..... 55  
  18.3 Barrel Racing (Western Only) ..... 56  
  18.4 Figure of 8 (Western Only) ..... 58  
  18.5 Team Relays ..... 58

**19. GROUP EVENTS: Drill Teams of 2 & 4 .....59**  
  19.1 General Information ..... 59  
  19.2 Judging ..... 60  
  19.3 Team Composition ..... 60  
  19.4 Theme ..... 60

**20. GROUP EVENTS: Unified Sports Team Relays .....60**  
  20.1 Unified Sports Relay Teams ..... 60  
  20.2 Required Athlete-Partner Ratio ..... 60  
  20.3 Walk-only and Trot-only divisions will be offered ..... 60  
  20.4 See the rules for Team Relays in Gymkhana Events. .... 60

**21. GROUP EVENTS: Unified Sports Drill Teams .....61**  
  21.1 Unified Sports Drill Teams ..... 61  
  21.2 Athlete Partner Ratio ..... 61  
  21.3 See the rules for Drill Teams above ..... 61

**22. Appendices .....62**





## 1. GOVERNING RULES

The Official Special Olympics Sports Rules for Equestrian shall govern all Special Olympics competitions. As an international sports program, Special Olympics has created these rules based upon International Equestrian Federation (FEI) rules for equestrian found at <http://www.fei.org>. FEI or National Governing Body (NGB) rules shall be employed except when they are in conflict with the Official Special Olympics Sports Rules for Equestrian or Article I. In such cases, the Official Special Olympics Sports Rules for Equestrian shall apply.

## 2. OFFICIAL EVENTS

The range of events is intended to offer competition opportunities for athletes of all abilities. Programs may determine the events offered and, if required, guidelines for the management of those events. Coaches are responsible for providing training and event selection appropriate to each athlete's skill and interest.

The following is a list of official events available in Special Olympics.

### 2.1 English Style Events

- 2.1.1 Dressage
- 2.1.2 Prix Caprilli
- 2.1.3 Equitation Jumping
- 2.1.4 English Equitation (required as a preliminary test)
- 2.1.5 Working Trails
- 2.1.6 Showmanship at Halter/Bridle Classes
- 2.1.7 Gymkhana Events
  - 2.1.7.1 Pole Bending
  - 2.1.7.2 Team Relays
  - 2.1.7.3 Concepts of Riding - Gymkhana Event for CS and BS riders
- 2.1.8 Drill Teams of twos and fours
- 2.1.9 Unified Sports Team Relays
- 2.1.10 Unified Sports Drill Teams

### 2.2 Western Style Events

- 2.2.1 Stock Seat Equitation (required as a preliminary test)
- 2.2.2 Western Riding
- 2.2.3 Showmanship at Halter/Bridle Classes
- 2.2.4 Gymkhana Events
  - 2.2.4.1 Pole Bending
  - 2.2.4.2 Barrel Racing
  - 2.2.4.3 Figure 8 Stake Race
  - 2.2.4.4 Team Relays
  - 2.2.4.5 Concepts of Riding - Gymkhana Event for CS and BS riders
- 2.2.5 Drill Teams of twos and fours
- 2.2.6 Unified Sports Team Relays
- 2.2.7 Unified Sports Drill Teams



### 3. RULES OF COMPETITION

- 3.1 Equestrian athletes are not separated by male-female or by age. All athletes compete according to ability.
- 3.2 All riders must have had at least 10 riding training sessions within the six months prior to competition.
- 3.3 Entries must be received by the event management on or before the entry deadline. No post entries will be allowed.
- 3.4 No dogs will be permitted on the show grounds, except Seeing Eye dogs or assistance dogs.
- 3.5 There will be a safety inspection of tack and equipment before riders mount.
- 3.6 In cases of broken equipment or loss of a shoe during competition, the rider may continue or be excused from the ring at the request of his/her coach.
- 3.7 Spotters, appointed by the event director, will remain in strategic places in the competition area to act in case of emergency for unassisted riders. Other attendants are not allowed in the competition ring except at the request of the judge(s) or when specified in the event requirements.
- 3.8 Outside assistance (rail side coaching) will be penalized at the judge's discretion. Electronic communication devices used for the purpose of communicating between riders and individuals outside the ring are prohibited.
- 3.9 Cue cards may be used for hearing impaired athletes. In order for the cues to be universal, they should be designated as follows:  
1=Walk, 2=Sitting Trot/Jog, 3=Posting Trot, 4=Canter/Lope, 0=Reverse, Universal Stop Sign=Halt
- 3.10 During the World Games, all tasks assigned by a judge must be translated into a rider's native language. Commands are given by a coach or a person authorized by a coach.
- 3.11 During World Games, all athletes will compete on horses provided by the organizing committee.
- 3.12 In competitions where riders do not bring their own horses, adequate time must be set aside to determine suitability of the rider to the horse.
- 3.13 In competitions where riders provide their own horses, the event director may require proof of a negative Coggins test.
- 3.14 A rider must use the same horse in all events during the entire competition.
- 3.15 Only two riders are allowed to compete on one horse. If two riders share one horse only one of them can be A level.
- 3.16 Under no circumstances should sedatives be used on horses for Special Olympic Equestrian Sport
- 3.17 Change of horse is only allowed for safety reasons or if a horse is sick or unsound.
- 3.18 The official veterinarian's decision, if called by the judge, as to the serviceable soundness of a horse will be final for the purpose of awarding medals and ribbons in the class for which the vet was called. Otherwise, the judge(s) and the equine director will make the final decision regarding a horse's ability to compete.
- 3.19 Unsoundness does not penalize a competitor unless it is sufficiently severe to impair the required performance. In such cases, the imposition of a penalty is at the judge's discretion.
- 3.20 In case of a grievance, the event director will consult the judge(s), competition steward and/or the Equestrian Sports Rules Committee. Their decision will be final.

### 4. ATTIRE

- 4.1 Clothing must be workmanlike and neat.
- 4.2 Boots
  - 4.2.1 All riders must wear heeled boots.
  - 4.2.2 Riders who must wear footwear as the result of a physical disability must have a physician's statement submitted with their Rider Profile. In this case, safety stirrups are obligatory.



4.2.3 English tack style riders must use Peacock safety stirrups, S-shaped stirrups or Devonshire boots if unable to wear to proper boots.

4.3 Helmets: All riders must wear protective SEI-ASTM or BHS approved helmets with full chin harness which must be fastened at all times when the riders are working around horses.

4.4 Number: Competitors must wear their assigned number prominently displayed on their backs during competition, practice at the competition and while in the competition "holding area" (stage).

4.5 During practice, athletes must adhere to the helmet, boots and long pants rule, but may wear short-sleeved shirts without riding coats.

4.6 For guidelines about attire appropriate or for different tack styles, refer to the English and Western sections of the rulebook.

## **5. TACK**

5.1 Saddles must fit the horse. Appropriate equipment is provided by the competition management in agreement with the horse owner.

5.2 An athlete may use his/her own saddle only if it fits the horse he/she is riding. If a rider plans to use his/her own saddle, it must be declared in the Rider Profile.

5.3 Adapted and personally owned saddles must be approved by the event director and horse owner prior to the competition.

5.4 Bridles must be appropriate to the class entered and meet the rule requirements. In International, National and Chapter competition, it is mandatory to have the bits dropped and inspected on all horses prior to competition.

5.5 Halters are required for all supported classes. A lead line must be attached to the halter and not to the bridle. The halter may be over or under the bridle as long as it doesn't interfere with the use of the bit or the reins.

5.6 Riders may use adaptive equipment without penalty. (Note: Riders may in no way be attached to the horse or saddle.) Adaptive equipment must be declared on the Rider Profile.

5.7 Prohibited Tack and Equipment (applies to warm-up as well as competition):

5.7.1 Bearing, side or running reins.

5.7.2 Seat covers—If an athlete needs a seat cover, it must be declared on the Rider Profile.

5.7.3 Boots and bandages, except where specifically approved as appropriate for a class. Boots may be used only if the horse is always ridden with boots and the owner insists on them.

5.7.4 Blinders

5.7.5 Nose covers

5.8 For guidelines about tack appropriate for different riding styles, refer to the English and Western sections of the rulebook.

## **6. JUDGING**

6.1 The following points (where appropriate) have equal consideration in judging all classes:

6.1.1 Rider's balance

6.1.2 Rider's seat

6.1.3 Use of aids

6.1.4 Ability to follow directions, ring etiquette and safety.

6.1.5 Sportsmanlike conduct

6.2 Results as shown by the performance of the horse are not to be considered more important than the method used in obtaining them.

6.3 Unauthorized assistance from horse handlers and side walkers will result in penalties.



- 6.3.1 Side walkers may not give verbal commands or extra physical prompting, except in case of emergency.
- 6.3.2 Special consideration will be given to riders with visual or auditory impairments or severe physical disability.
- 6.3.3 Coaches may not act as horse handlers, side walkers or spotters for their own athlete anytime while that athlete is being judged.
- 6.4 For guidelines about judging specific events, refer to the English and Western sections of the rulebook.

## **7. HOSTING A COMPETITION**

- 7.1 Facility and Equipment Requirements – General Requirements for all Events
  - 7.1.1 A sound system.
  - 7.1.2 A portable fencing system for crowd control and designating other restricted areas.
  - 7.1.3 A designated spectator area located well away from in and out gates of the arena/ring.
  - 7.1.4 During competition, an exercise/warm-up ring located far enough from the competition ring so as not to interfere with athletes who are being judged.
  - 7.1.5 Solid ramps or stairs for horse mounting.
  - 7.1.6 Arenas with sturdy fencing and solid gates, good drainage, and suitable level footing with the following minimum dimensions:
    - 7.1.6.1 Prix Caprilli—min. 70 x 30 meters
    - 7.1.6.2 Equitation jumping – min. 60 x 30 meters
    - 7.1.6.3 Gymkhana Events, Dressage, Western Riding and Drill Teams—50 x 30 meters
    - 7.1.6.4 Working Trails, Showmanship, Equitation—30 x 25 meters
    - 7.1.6.5 Warm-up Arenas—40 x 20 meters, or any combination that equals 35 meters of overall rail space with no less than 20 meters in length for the short wall.
- 7.2 Invitations and Entries
  - 7.2.1 The competition management sends out the invitations with information about the date, time, venue, deadline for sending applications, events and other important data.
  - 7.2.2 Persons interested in participation in a competition should submit the Entry Form and thoroughly completed Rider Profile before the deadline.
- 7.3 Head Coaches' Meeting
  - 7.3.1 Before the beginning of the competition, the event management appoints the day and time of the Head Coaches' Meeting, where the participants have the opportunity to get acquainted with the facilities.
  - 7.3.2 The event management is responsible for giving the participants all the crucial information necessary to ensure a proper course of a competition.
  - 7.3.3 The event management is obliged to answer accurately and in detail all the questions that participants might have. If necessary, the event management appoints the date of another Head Coaches' Meeting.
- 7.4 Matching Horses

An important characteristic of Special Olympics is the fact that horses are provided by the event management. Matching horses is the first and one of the most important stages. The organizer suggests a horse to a rider on the basis of the information included in the Rider Profile. That's why





it is extremely important to fill out this form with utmost care and attention. This is the coach's responsibility.

**7.5 Practicing**

- 7.5.1 If riders do not bring their own horses, adequate time must be set aside to determine suitability of the rider to the horse.
- 7.5.2 Every rider is entitled to exercise the elements of the event he/she competes in. Therefore, the event management is obligated to provide access to:
  - 7.5.2.1 Training ring
  - 7.5.2.2 Dressage arena—for riders competing in Dressage and Prix Caprilli.
  - 7.5.2.3 Some difficult elements of Working Trail—for riders participating in this event.
  - 7.5.2.4 Elements of Gymkhana events
  - 7.5.2.5 Equitation Jumping – In the warm-up arena there must be 2 jumps for riders who compete in jumping
- 7.5.3 During practice, coaches must establish, ultimately and undoubtedly, whether a horse is suitable for a rider. Changing horses for safety reasons is still allowed at this stage. After preliminary tests, changing of horses is possible only when a horse is sick or unsound.

**8. DIVISIONING**

- 8.1 It should be noted that all riders compete according to ability. Equestrian athletes are not separated by gender or by age. According to the Special Olympics Sports Rules, divisions should consist of 3–8 riders.
- 8.2 Definitions:
  - 8.2.1 Support (S)—Rider needs the physical support of one or two side walkers and/or the presence of a leader. Any help in the arena is considered “supported.”
  - 8.2.2 Independent (I)—Independent riders may not be helped while competing.
- 8.3 Division Levels:
  - 8.3.1 A Level: Walk, Trot/Jog, Canter/Lope. Independent only. Rider is expected to compete with no modifications to NGB rules. Can perform any class requirements
  - 8.3.2 B Level: Walk, Trot/Jog
    - 8.3.2.1 BI—Independent, can perform any class requirements.
    - 8.3.2.2 BS—Supported, can physically perform any class requirements.
  - 8.3.3 C Level: Riders will ride at the walk only.
    - 8.3.3.1 CI—Independent.
    - 8.3.3.2 CS—Supported
  - 8.3.4 Rider’s Division Level

Event	English/Western	CS	CI	BS	BI	A
Dressage	English	No	Yes	No	Yes	Yes
Prix Caprilli	English	No	No	No	No	Yes
Equitation Jumping	English	No	Yes	No	Yes	Yes
English Equitation	English	Yes	Yes	Yes	Yes	Yes
English Working Trail	English	Yes	yes	Yes	Yes	Yes
Stock Seat Equitation	Western	Yes	Yes	Yes	Yes	Yes
Western Working Trail	Western	Yes	Yes	Yes	Yes	Yes
Gymkhana – Pole Bending	Both	No	Yes	No	Yes	Yes
Gymkhana – Barrell Racing	Western	No	No	No	Yes	Yes
Gymkhana – Figure of 8	Western	No	No	No	Yes	Yes
Gymkhana – Concepts of Riding	Both	Yes	No	Yes	No	No



Gymkhana – Team Relays	Both	Yes	Yes	Yes	Yes	Yes
Showmanship at Halter/Bridle	Both	No	Yes	No	Yes	Yes
Drill Teams	Both	Yes	Yes	Yes	Yes	Yes
Unified Sports Team Relays	Both	Yes	Yes	Yes	Yes	Yes
Unified Sports Drill Teams	Both	Yes	Yes	Yes	Yes	Yes

8.3.4.1 The first step in divisioning:

- 8.3.4.1.1 Riders are assigned to a division level (CS, CI, BS, BI, A) according to their ability to negotiate safely any movements required in the event. The ability is indicated by a Rider Profile, which is completed by the Special Olympics coach prior to competition and submitted with the athlete's entry form.
- 8.3.4.1.2 Rider Profiles must indicate the information about physical inability to wear boots with a heel, supported by a physician's statement.
- 8.3.4.1.3 For event management—These conditions must be marked on the judge's forms and on the numbers on the rider's back. Riders may enter any or all events from their division, but may not cross enter division levels.

8.3.4.2 The second step—preliminary test:

- i. Obligatory for all riders.
- ii. English Equitation or Stock Seat Equitation test will be used to separate riders into proper ability divisions.
- iii. After horse matching and practice, all riders participate in preliminary equitation tests.
- iv. All tests are adequate to division levels declared in the Rider Profile.
- v. All preliminary tests must be announced before competition. (At the Head Coaches' Meeting, in the Coaches' Handbook, etc.) No set test for equitation. Judges will ask riders to undertake tasks to demonstrate what is required on marking sheet.
- vi. The role of the judges is crucial at this stage! Based on their results, competitors will be assigned to appropriate divisions, and order to compete with riders of similar abilities. It is very important for the judges to assess the abilities of the riders accurately, to distinguish between poor, average and very good performances.

**9. ENGLISH STYLE EVENTS**

**10. DRESSAGE**

Event	CS	CI	BS	BI	A
Dressage	No	Yes	No	Yes	Yes

10.1 General Information (Dressage and Prix Caprilli)

- 10.1.1 The object of dressage is the harmonious development of the physique and ability of the horse. As a result of the communication with and understanding of the rider, the horse is not only calm, supple and balanced, but also confident, attentive and keen. The horse thus gives the impression of doing of his own accord what is required of him. Confident and attentive, he submits generously to the control of the rider.



- 10.1.2 During the entire dressage test, the rider should strive to keep the horse “on the bit,” a skill which is the result of consistent and continuous work between the horse and rider. In competitions where riders are competing on borrowed horses reasonable contact is sufficient.

10.2 Facilities and Set-up

- 10.2.1 The arena should be on as level ground as possible and should measure 40 meters by 20 meters. These measurements are for the interior of the enclosure.
- 10.2.2 The enclosure itself should consist of a low fence about .30 meters (12") high. The part of the fence at the letter A should be easy to remove to let the competitors in and out of the arena. The letter A should be placed at least 5 meters away from the arena.
- 10.2.3 The letters should be placed outside the arena, about .50 meters from the fence. d. All letters should be clearly marked and large enough to see from a distance.
- 10.2.4 So the judges can note the exact point on the track opposite each letter, there should be either a red stake inside against the fence or a red line painted on the fence.
- 10.2.5 The entire centerline and the three points D, X and G should be as clearly marked as possible. On a grass arena, the centerline should be mowed shorter than the other parts of the arena. On a sand arena, the centerline should be rolled or raked.
- 10.2.6 It is permissible to decorate the arena with flowers and greenery, as long as the decorations are not distracting to the horses.
- 10.2.7 Location of the judges
  - 10.2.7.1 Ideally, there will be two judges—one at the letter C and one at either B or E.
  - 10.2.7.2 If there is only one judge, he/she should be placed 5 meters from the end of the arena at C.
  - 10.2.7.3 A separate enclosure should be provided for each judge. To give the judge a good view of the arena, the enclosure should be raised at least 0.50 meters above the ground.

10.2.8 Small Arena Diagram

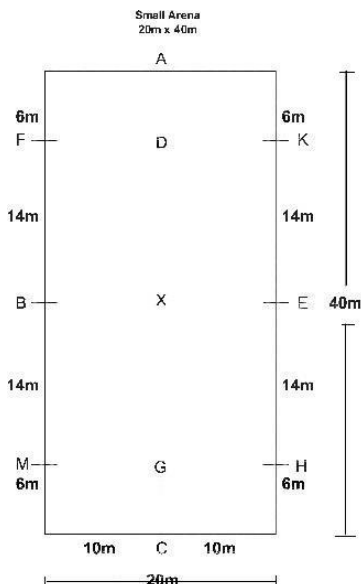

10.3 Judging

- 10.3.1 The mark for each movement in the dressage test should first establish the fact of whether the movement is performed either insufficiently (4 or below) or sufficiently (5 or above).



- 10.3.2 Accuracy (moderate) should be a factor only if inaccuracy avoids the difficulty of the movement.
- 10.3.3 A movement which must be carried out at a certain point in the arena should be performed at the moment when the competitor's body is at that point.
- 10.3.4 If a problem appears once, it may be treated lightly by the judge. Repeated occurrences should be penalized more severely.
- 10.3.5 In the case of a fall of the horse and/or rider, the athlete will not be eliminated. He/she will be penalized by the effect of the fall on the execution of the movement being performed, as well as in the Collective Marks.
- 10.3.6 If, during the test, the horse leaves the arena (all four feet outside the fence or line marking the arena perimeter), the rider is eliminated, but may, at the judge's discretion, complete the test.
- 10.3.7 An athlete leaving the arena at the end of the ride in any way other than prescribed in the test will be penalized by an error.
- 10.3.8 The judge may stop a test and/or allow an athlete to restart from the beginning or from any appropriate point in the test if some unusual circumstance has occurred to interrupt the test.
- 10.3.9 When the entry bell or whistle sounds, the rider has 90 seconds to enter the arena. Failure to do so will result in the rider being eliminated.
- 10.3.10 No rider can be required to ride prior to their scheduled time without 1–2 hours notice.
- 10.3.11 All movements and certain transitions from one to another which have to be marked by the judge(s) are numbered on the judges sheets. Each movement will receive a score from 0 to 10. The lowest mark is 0 and is given to a movement that is "not executed", which means that practically nothing of the required movement has been performed. Ten represents the highest mark.
- 10.3.12 The scale of marks is as follows:
- |                |                  |
|----------------|------------------|
| 10 Excellent   | 5 Sufficiently   |
| 9 Very Good    | 4 Insufficiently |
| 8 Good         | 3 Fairly Bad     |
| 7 Fairly Good  | 2 Bad            |
| 6 Satisfactory | 1 Very Bad       |
|                | 0 Not Executed   |
- 10.3.13 The Collective Marks as well as certain difficult and/or frequently repeated movements are given a coefficient, which means they are multiplied by the coefficient number. Coefficients are noted on the judges sheets.
- 10.3.14 Collective marks are awarded after the athlete has finished his/her performance in the following categories:
- 10.3.14.1 Rider's balance and position.
- 10.3.14.2 Equestrian feel and skill, the effectiveness of the aids.
- 10.3.14.3 The confidence of the rider and keeping the activity of the horse.
- 10.3.14.4 Rider's ability to influence the direction of the horse and the accuracy.
- 10.3.15 After each performance, when the judge has completed the Collective Marks, the judges sheets pass into the hands of the scorers, who tabulate the score in the following manner:
- 10.3.15.1 The marks are multiplied by the corresponding coefficients, where applicable, and then totaled.
- 10.3.15.2 Penalty points incurred for errors in the execution of the tests are then deducted on each judge's sheet.
- 10.3.15.3 The score for the classification is obtained by adding the total points.



- 10.3.15.4 With more than one judge, the sum total classifies.
- 10.3.15.5 If there are two or more judges, the points awarded by each judge will be published separately, in addition to the total score.
- 10.3.15.6 In all competitions, the winner is the athlete having the highest total of points; the second winner is the athlete with the next highest total of points, and so on.
- 10.3.15.7 If two athletes have an equal number of total points, the athlete with the highest marks under the Collective Marks shall be declared the winner.
- 10.3.15.8 When the scores in the Collective Marks also tie, the judge may be required to review the score sheets and either declare a winner or decide to maintain the tie.
- 10.4 Gaits
- 10.4.1 Halt
- 10.4.1.1 At the halt, the horse's neck should be raised, the poll high, and the head slightly in front of the vertical.
- 10.4.1.2 While remaining "on the bit" and maintaining a light and soft contact with the rider's hands, the horse may quietly chomp the bit and should be ready to move off at the slightest indication of the rider.
- 10.4.2 Walk
- 10.4.2.1 **Walk:** A regular and unconstrained walk in which the horse is energetic but calm, moving with even, determined steps, showing four distinctly marked, evenly spaced beats. The hind feet should step forward into the prints of the fore feet. The rider should maintain a light, steady contact with the horse's mouth.
- 10.4.2.2 **Free Walk on Long Reins:** A pace of relaxation in which the horse is allowed complete freedom to lower and stretch out his head and neck.
- 10.4.3 Trot:
- 10.4.3.1 **Trot:** This is a pace in which the horse moves in proper balance and, remaining "on the bit," goes forward with even, elastic steps and good hock action. The expression "good hock action" does not mean that collection is required. It only underlines the importance of impulsion originating from activity of the hindquarters.
- 10.4.4 Canter:
- 10.4.4.1 **Canter:** This is a pace in which a horse moves in proper balance and, remaining "on the bit," goes forward with even, light and cadenced strides and push from the hindquarters. This underlines the importance of impulsion originating from the activity of the hindquarters.
- 10.5 Position and Aids of the Rider
- 10.5.1 All movements should be executed without apparent effort of the rider.
- 10.5.2 The athlete should be well balanced and the legs should be steady.
- 10.5.3 The upper body should be easy, free and erect.
- 10.5.4 The hands should be low and close together without, however, touching each other or the horse. The thumb will be the highest point.
- 10.5.5 The elbows and arms should be close to the body, enabling the rider to follow the movement of the horse smoothly and freely, as well as to apply his/her aids imperceptibly.
- 10.5.6 Riding with both hands is obligatory.
- 10.6 Execution of Dressage Tests
- 10.6.1 Calling Tests
- 10.6.1.1 All Special Olympics Dressage and Prix Caprilli tests may be called/read.





- 10.6.1.2 If a test is to be called, it is the responsibility of the coach to arrange for a person to read the test. At the World Games, the coach may read the test in the athlete's native language.
- 10.6.1.3 Lateness in calling the movements and errors in the reading of the test will not relieve the rider from error penalties.
- 10.6.1.4 Calling the test is limited to reading the movement as it is written only once. Repeating movements by the caller will constitute unauthorized assistance.
- 10.6.1.5 Calling except for safety reasons, unauthorized assistance by the person calling the test or anyone else is prohibited and is cause for elimination.
- 10.6.2 Salute
- 10.6.2.1 At the salute, the rider must take the reins in one hand, let the other arm drop loosely along the body, and then incline the head in a slight bow.
- 10.6.3 Voice
- 10.6.3.1 The use of the voice in any way whatsoever, including clucking of the tongue once or repeatedly, is a serious fault and will involve a deduction of at least 1–2 marks for the movement where this occurred.
- 10.6.4 Errors
- 10.6.4.1 When an athlete makes an “error of the course” (e.g. takes the wrong turn, omits a movement, etc.) the judge warns the athlete by sounding the bell or blowing the whistle. The judge shows the athlete, if necessary, the point at which the test is to be taken up again and the next movement to be executed. The judge then leaves the athlete to continue unassisted.
- 10.6.4.2 In some cases, when the athlete makes an “error of the course.” the sounding of the bell might unnecessarily impede the fluency of the performance. In these instances, it is at the judge's discretion whether to sound the bell or not.
- 10.6.4.3 In Special Olympics tests, every “error of the course,” whether the bell is sounded or not, must be penalized in the following manner:
- The first time by 1 point
  - The second time by 2 points
  - The third time by 4 points
  - The fourth time by Elimination, although the athlete may continue his/her performance to the end.
- 10.6.4.4 When an athlete makes an “error of the test” (e.g. does not take the reins in one hand at the salute, etc.) he/she must be penalized as for an “error of the course.” The same applies for a rider leaving the arena at the end of his/her performance in a way other than prescribed in the test.
- 10.6.4.5 If the judge has not noted an error, the athlete has the benefit of the doubt.
- 10.6.4.6 The penalty points are deducted on each judge's sheet from the total points earned by the athlete.
- 10.7 Dressage Tests
- 10.7.1 All trot movements in dressage may be ridden sitting or rising, as the competitor wishes.
- 10.7.2 A period of not less than five minutes should be allowed for the completion of each test.
- 10.7.3 The following dressage tests are used for Special Olympics events. These forms may be used as judges score sheets.



**EQ LEVEL A DRESSAGE (WALK - TROT - CANTER) TEST #1**

Competition: \_\_\_\_\_ Bib #: \_\_\_\_\_  
 Division: A \_\_\_\_\_ Name of Rider: \_\_\_\_\_  
 Horse Name: \_\_\_\_\_ Delegation: \_\_\_\_\_  
 Scale of Marks: \_\_\_\_\_ Errors on Course: \_\_\_\_\_

10 Excellent	9 Very Good	8 Good	First Error	0.5 percentage points
7 Fairly Good	6 Satisfactory	5 Sufficient	Second Error	1.0 percentage points
4 Insufficient	3 Fairly Bad	2 Bad	Third Error	Elimination
1 Very Bad	0 Not Executed			

	TEST	MARKS	POINTS	COEF.	TOTAL	REMARKS
1	A X C Enter Trot Halt, Immobility Salute, Proceed in Trot Track Right	10				
2	MF One Simple Loop (5 Meters)	10				
3	Bt. F&A Canter right lead	10				
4	E Circle right 20 meters diameter	10				
5	H Trot					
6	B Before B Circle right 20 meters, trot rising, letting the horse gradually take the reins out of hands. Gradually take up the reins. Trot and proceed straight ahead	10		X2		
7	A Walk	10				
8	KXM M Free walk on a long rein Walk	10		X2		
9	C Trot	10				
10	HK One Simple Loop (5 Meters)	10				
11	Bt. K&A Canter left lead	10				
12	B Circle left 20 meters	10				
13	M Trot	10				
14	E B Turn Left Turn Right	10				
15	A X Down Centerline, Salute Halt through Walk, Immobility, Salute	10				

Leave arena in walk.

Collective Marks	MARKS	POINTS	COEF.	TOTAL	REMARKS
Riders Balance + Position	10		X2		
Equestrian Feel and Skill, the Effectiveness of aids	10		X2		
The confidence of the Rider and Keeping the Activity of the Horse	10		X2		
Riders Ability to Influence the Direction of the Horse and the Accuracy	10		X2		

Subtotal: \_\_\_\_\_  
 Errors: \_\_\_\_\_  
 Total Points: \_\_\_\_\_  
 Percentage: \_\_\_\_\_

Judges Name: \_\_\_\_\_  
 Judges Signature: \_\_\_\_\_



**EQ LEVEL A DRESSAGE (WALK - TROT - CANTER) TEST #2**

Competition:	Bib #:			
Division: A	Name of Rider:			
Horse Name:	Delegation:			
Scale of Marks:	Errors on Course:			
10 Excellent	9 Very Good	8 Good	First Error	0.5 percentage points
7 Fairly Good	6 Satisfactory	5 Sufficient	Second Error	1.0 percentage points
4 Insufficient	3 Fairly Bad	2 Bad	Third Error	Elimination
1 Very Bad	0 Not Executed			

TEST		MARKS	POINTS	COEF.	TOTAL	REMARKS
1	A	10				
	X					
	C					
	Enter Trot Halt, Immobility, Salute, Proceed in Trot Track Left					
2	E	10				
	Circle left 20 meters diameter					
3	Bt. K&A	10				
	Canter Left Lead					
4	A	10				
	Circle left 20 meters diameter					
5	Bt. B&M	10				
	Trot					
6	C	10				
	Walk					
7	HXF	10				
	F					
	Free Walk on long rein Walk					
8	A	10				
	Trot					
9	E	10				
	Circle right 20 meters diameter					
10	Bt. H&C	10				
	Canter right lead					
11	C	10				
	Circle right 20 meters diameter					
12	Bt. B&F	10				
	Trot					
13	A	10				
	X					
	Down centerline Halt, Immobility, Salute					

Leave arena in walk.

Collective Marks	MARKS	POINTS	COEF.	TOTAL	REMARKS
Riders Balance + Position	10		X2		
Equestrian Feel and Skill, the Effectiveness of aids	10		X2		
The confidence of the Rider and Keeping the Activity of the Horse	10		X2		
Riders Ability to Influence the Direction of the Horse and the Accuracy	10		X2		

Subtotal:	Judges Name:
Errors:	
Total Points:	Judges Signature:
Percentage:	



**EQ LEVEL BI DRESSAGE (WALK - TROT) TEST #1**

Competition: \_\_\_\_\_

Bib #: \_\_\_\_\_

Level: B-I \_\_\_\_\_

Name of Rider: \_\_\_\_\_

Horse Name: \_\_\_\_\_

Delegation: \_\_\_\_\_

Scale of Marks:

Errors on Course:

10 Excellent	9 Very Good	8 Good	First Error	0.5 percentage points
7 Fairly Good	6 Satisfactory	5 Sufficient	Second Error	1.0 percentage points
4 Insufficient	3 Fairly Bad	2 Bad	Third Error	Elimination
1 Very Bad	0 Not Executed			



	TEST	MARKS	POINTS	COEF.	TOTAL	REMARKS
1	A X X-C Enter Trot Halt (Over Walk), Immobility, Salute Proceed in Trot	10				
2	C Track Right	10				
3	M Trot	10				
4	B B Circle right 20 mtr, Trot Straight Ahead	10				
5	Bt. B&F Walk	10				
6	KXM M Free Walk on Long Rein Walk	10				
7	C Trot	10				
8	E E Circle Left 20 mtr, Trot Straight Ahead	10				
9	A X Down centerline Halt, Immobility, Salute	10				

Leave arena in walk.

Collective Marks	MARKS	POINTS	COEF.	TOTAL	REMARKS
Riders Balance + Position	10		X2		
Equestrian Feel and Skill, the Effectiveness of aids	10		X2		
The confidence of the Rider and Keeping the Activity of the Horse	10		X2		
Riders Ability to Influence the Direction of the Horse and the Accuracy	10		X2		

Subtotal: \_\_\_\_\_

Judges Name: \_\_\_\_\_

Errors: \_\_\_\_\_

Total Points: \_\_\_\_\_

Judges Signature: \_\_\_\_\_

Percentage: \_\_\_\_\_



**EQ LEVEL BI DRESSAGE (WALK - TROT) TEST #2**

Competition: \_\_\_\_\_

Bib #: \_\_\_\_\_

Level: B-I \_\_\_\_\_

Name of Rider: \_\_\_\_\_

Horse Name: \_\_\_\_\_

Delegation: \_\_\_\_\_

Scale of Marks:

Errors on Course:

10 Excellent	9 Very Good	8 Good	First Error	0.5 percentage points
7 Fairly Good	6 Satisfactory	5 Sufficient	Second Error	1.0 percentage points
4 Insufficient	3 Fairly Bad	2 Bad	Third Error	Elimination
1 Very Bad	0 Not Executed			

**TEST MARKS POINTS COEF. TOTAL REMARKS**

1	A	Enter in Walk	10				
	X	Halt, Immobility, Salute, Proceed in Walk					
2	C	Track Left	10				
	H	Trot, Continue around the arena to A					
3	A	Circle Left 20 mtr diameter	10				
	A F	Trot					
4	F	Walk	10				
	B	Turn Left					
	E	Track Right					
5	H	Trot, continue around the arena to A	10				
6	A	Circle right 20 mtr diameter in Trot	10				
	A	Walk					
7	K-H	Free Walk on Long Rein	10				
8	C	Trot, continue around the arena to A	10				
9	A	Down centerline	10				
	X	Halt, Immobility, Salute					

Leave arena in walk.

Collective Marks	MARKS	POINTS	COEF.	TOTAL	REMARKS
Riders Balance + Position	10		X2		
Equestrian Feel and Skill, the Effectiveness of aids	10		X2		
The confidence of the Rider and Keeping the Activity of the Horse	10		X2		
Riders Ability to Influence the Direction of the Horse and the Accuracy	10		X2		

Subtotal: \_\_\_\_\_

Judges Name: \_\_\_\_\_

Errors: \_\_\_\_\_

Total Points: \_\_\_\_\_

Judges Signature: \_\_\_\_\_

Percentage: \_\_\_\_\_





**EQ LEVEL CI DRESSAGE (WALK) TEST #1**

Competition: _____	Bib #: _____			
Level: CI _____	Name of Rider: _____			
Horse Name: _____	Delegation: _____			
Scale of Marks:	Errors on Course:			
10 Excellent	9 Very Good	8 Good	First Error	0.5 percentage points
7 Fairly Good	6 Satisfactory	5 Sufficient	Second Error	1.0 percentage points
4 Insufficient	3 Fairly Bad	2 Bad	Third Error	Elimination
1 Very Bad	0 Not Executed			

	TEST	MARKS	POINTS	COEF.	TOTAL	REMARKS
1	A X Enter in Walk Halt, Immobility, Salute, Proceed in Walk	10				
2	C Track Left	10				
3	E E Circle Left 20 mtr Straight Ahead	10				
4	FXH Change Rein in Free Walk on a Long Rein	10				
5	H-C-M Walk	10				
6	MF Simple Loop (5 meters)	10				
7	A-K-E E Walk Circle right 20 mtr	10				
8	MXK Change the Rein	10				
9	A X Down centerline Halt, Immobility, Salute	10				

Leave arena in walk.

Collective Marks	MARKS	POINTS	COEF.	TOTAL	REMARKS
Riders Balance + Position	10		X2		
Equestrian Feel and Skill, the Effectiveness of aids	10		X2		
The confidence of the Rider and Keeping the Activity of the Horse	10		X2		
Riders Ability to Influence the Direction of the Horse and the Accuracy	10		X2		

Subtotal: \_\_\_\_\_

Errors: \_\_\_\_\_

Total Points: \_\_\_\_\_

Percentage: \_\_\_\_\_

Judges Name: \_\_\_\_\_

Judges Signature: \_\_\_\_\_



EQ LEVEL CI DRESSAGE (WALK) TEST #2

Competition: \_\_\_\_\_

Bib #: \_\_\_\_\_

Level: CI \_\_\_\_\_

Name of Rider: \_\_\_\_\_

Horse Name: \_\_\_\_\_

Delegation: \_\_\_\_\_

Scale of Marks:

Errors on Course:

- 10 Excellent                      9 Very Good    8 Good
- 7 Fairly Good                    6 Satisfactory 5 Sufficient
- 4 Insufficient                    3 Fairly Bad    2 Bad
- 1 Very Bad                        0 Not Executed

- First Error            0.5 percentage points
- Second Error        1.0 percentage points
- Third Error           Elimination

	TEST	MARKS	POINTS	COEF.	TOTAL	REMARKS
1	A X Enter in Walk Halt, Immobility, Salute Proceed in Walk	10				
2	C M-X-K K Turn Right in Walk Free Walk on a Long Rein Walk	10				
3	A Walk Continue Down Long Side to C	10				
4	C Circle left 20 mtr	10				
5	H-X-F Change Rein Free Walk on Long Rein	10				
6	A Circle Right 20 mtr	10				
7	A-K-E E Walk Turn Right	10				
8	B Turn Right, Continue to A	10				
9	A X Down centerline Halt, Immobility, Salute	10				

Leave arena in walk.

Collective Marks	MARKS	POINTS	COEF.	TOTAL	REMARKS
Riders Balance + Position	10		X2		
Equestrian Feel and Skill, the Effectiveness of aids	10		X2		
The confidence of the Rider and Keeping the Activity of the Horse	10		X2		
Riders Ability to Influence the Direction of the Horse and the Accuracy	10		X2		

Subtotal: \_\_\_\_\_

Judges Name: \_\_\_\_\_

Errors: \_\_\_\_\_

Total Points: \_\_\_\_\_

Judges Signature: \_\_\_\_\_

Percentage: \_\_\_\_\_



**11. PRIX CAPRILLI**

Event	CS	CI	BS	BI	A
Prix Caprilli	No	No	No	No	Yes

11.1 General Information (Refer to the Dressage section)

11.2 Facilities and Set-up

11.2.1 The arena should be set up the same as for Dressage with the dimensions 20m X 60m.

11.2.2 Jump fences:

11.2.2.1 Fences 1 and 2 should be placed on the line AXC, with their centers exactly 11m (36') from X.

11.2.2.2 The height of fences 1 and 2 should be set at 45cm (18").

11.2.2.3 Fences 3 and 4 should be placed on the line BXE, spaced 2.5m (8') from the arena fence.

11.2.2.4 The height of fence 3 should be set at 60cm (24").

11.2.2.5 Fence 4 will be an oxer set at 60 cm (24") height, with no more than a 60cm (24") spread.

11.2.2.6 The top elements of all fences must rest in jump cups mounted on jump standards.

11.2.2.7 Fences should be painted white or a neutral color and may be tastefully decorated with flowers, shrubs, etc.

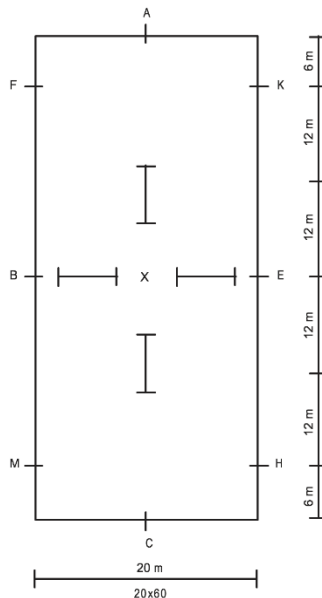

11.2.2.8 The minimum width between the jump standards is 3m (10'). The maximum width between the jump standards is 3.6m (12').

11.3 Judging

11.3.1 Each movement in the test is awarded 0-10 points as in a Dressage test

11.3.2 Jumping penalties:

- 1) Knocking down obstacle 2 faults



- |        |  |  |
|--------|--|--|
|        | 2) First refusal (run out)   | 3 faults   |
|        | 3) Second refusal  | 3 faults   |
|        | 4) Third refusal   | Elimination, although the athlete may continue his/her performance to the end. |
| 11.3.3 | Errors of Course:  |  |
|        | 1) First error   | 1 penalty point  |
|        | 2) Second error  | 2 penalty points   |
|        | 3) Third error   | 4 penalty points   |
|        | 4) Fourth error  | Elimination, although the athlete may continue his/her performance to the end. |
|        | 5) Use of voice  | 2 penalty points   |
| 11.3.4 | On the judges sheet, the marks allotted for each movement are tabulated as in Dressage and penalty points are deducted from the total. |  |
| 11.4   | Prix Caprilli Tests  |  |
| 11.4.1 | The test may be called/read to the athlete. See rules for calling tests in the Dressage section.                                       |  |
| 11.4.2 | The walk will be performed working and the trot will be performed rising, unless otherwise stated.                                     |  |



**Level A Prix Caprilli Test**

Competition: EQ Equestrian English Equitation    Level: A    Bib No: \_\_\_\_\_

Division: \_\_\_\_\_ Name of Rider: \_\_\_\_\_

Horse Name: \_\_\_\_\_ Delegation: \_\_\_\_\_

Arena: Small (20m x 40m)  
Maximum possible points: 200

TEST	POINTS	REMARKS
1. A A K E H C	Enter and immediately halt, Salute Turn left, proceed at working walk to C	
2. Between C & M A C	Working trot to A Turn down center making two loops by leaving fence No. 1 on the right and fence No. 2 on the left Turn left	
3. E B M	Half circle left on diameter EB and jump fence No 1 Working trot to C	
4. C A	Turn down center making two loops by leaving fence No 1 on the left and fence No. 2 on the right Turn right	
5. E	Half circle right on diameter and jump fence No 2	
6. B F A K E H	Working trot to A Working trot sitting	
7. Between H & C M B F K E H C	Working center right lead Around arena to C	
8. After C	Turn right and jump fence No. 3 and return to track near A leaving No. 1 on right	
9. Before H C M X X X K	Working trot Walk Change rein at working walk Halt immobile for 6 seconds Working walk	
10. A	Working trot sitting	
11. Between M & C H E K A F B M C	Working canter left lead Around arena to C	
12. After C	Turn left and jump fence No. 4 and return to track near A, leaving fence No. 1 on left	
13. Before M C E X	Working trot Walk Half circle left on diameter E X Halt, Salute facing the judge and leave arena at free walk on long rein at A	
Leave arena at walk at A - Sitting trot, rising trot or any combination thereof may be used when trot work is requires.		
<b>Collective Remarks</b>	<b>Pts.</b>	<b>Coef.</b>
Rider's balance & position	2	2
Equestrian feel & skill, the effectiveness of the aids	2	2
Confidence of the rider & keeping activity of the horse	2	2
Rider's ability to influence direction of the horse & the accuracy	1	1

Further Remarks; \_\_\_\_\_  
 Subtotal: \_\_\_\_\_  
 Errors: (-) \_\_\_\_\_  
 Total Points: \_\_\_\_\_

Judges Name: \_\_\_\_\_

Judges Signature: \_\_\_\_\_

Revision Date: September 2016





**12. EQUITATION JUMPING**

Event	CS	CI	BS	BI	A
Equitation Jumping	No	Yes	No	Yes	Yes

12.1 General Information: Equitation jumping is the physical application of correct riding techniques while jumping a simple course of fences. It is judged over one round and no time is involved. Rider is judged on their correct approach to the fence and position over the fence.

Rider with the highest score is the winner. Facilities and set-up. Arena 30mx60m.

12.2 Levels of Competition

- 12.2.1 Walk (Levels CI) – Athletes will walk a course of 4-8 ground poles, and will be judged on accuracy of the course correct approach to the jump and position over the jump. Jumps will be 15 cm.
- 12.2.2 Walk-Trot (Levels , BI) – Athletes will walk/trot a course of 6-8 ground poles, and be judged on accuracy of the course correct approach to the jump and position over the jump. Level BI riders will trot the course. **MAXIMUM HEIGHT FOR LEVEL BI IS 30 cm. THESE ARE FENCES, NOT GROUND POLES**
- 12.2.3 Walk-Trot-Canter (Level A) – Athletes will canter a course of 5-8 fences with a maximum height of 60 cm and be judged on accuracy of the course, jumping, and position of the rider correct approach to the jump and position over the jump. **SHOULD BE 6-8 FENCES**

12.3 Rules of competition

- 12.3.1 Jumping courses will not be timed.
- 12.3.2 Whips and spurs are not allowed, except with special permission from show management, requested before the class begins.
- 12.3.3 In Level A, when the judge blows the whistle, the athlete may ride a courtesy circle before beginning the course.
- 12.3.4 In Level A, the athlete is allowed to ride a courtesy circle after the last fence, before leaving the arena.

12.4 Facilities and Set-up

- 12.4.1 The course should be set in a fenced arena.
- 12.4.2 The top elements of all fences must rest in jump cups mounted on jump standards.
- 12.4.3 Fences should be painted white or a neutral color and may be tastefully decorated with flowers, shrubs, etc.
- 12.4.4 The minimum width between the jump standards is 3m (10'). The maximum width between the jump standards is 3.6m (12').
- 12.4.5 Courses should include poles around the edge of the arena and on a diagonal, with a change of direction.
- 12.4.6 The center section of the ground poles should be painted a different color.
- 12.4.7 The course should be posted well in advance of competition, and if possible, athletes should be allowed to school over the course.
- 12.4.8 The rider with the highest score is winner as each jump is marked out of 10 with 10 being the highest score (see judges' sheet).

12.5 Judging – Each fence/ground pole is marked out of 10 points. The emphasis should be on the position and effectiveness of the rider, not the quality of the horse.



- 12.5.1 Jumping penalties
  - Knocking down obstacle (Level A) 2 faults
  - Knocking ground pole (Levels B,C) 2 faults
  - First refusal (run out) 3 faults
  - Second refusal 3 faults
  - Third refusal Elimination (athlete may complete the course)
  - Not going over center section of ground pole (Levels B, C) Up to 10 penalty points
- 12.6 Errors of position (Examples, See Judge Scoresheet)
  - 12.6.1 Loss of balance/position over fence 2 penalty points all of these are determined by judge and marked as on judges form
  - 12.6.2 Inability to maintain specified gait
  - 12.6.3 Ineffective use of the aids



**Equitation Jumping**

Competition: \_\_\_\_\_

Bib #: Name of \_\_\_\_\_

Division: \_\_\_\_\_

Rider: \_\_\_\_\_

Horse Name: \_\_\_\_\_

Delegation: \_\_\_\_\_

Faults:

1st Refusal 3 Faults

Knocked Down 2 Faults

2nd Refusal 3 Faults

Error on Course 2 Faults

3rd Refusal Elimination

Note: Trotting between the obstacles in Level A is not marked as a fault and does not penalize points

Jump	Refusals	Knocks	Wrong Course	Marks	Points	REMARKS
1						
2						
3						
4						
5						
6						
7						
8						
9						
10						

Judging		REMARKS
Each Jump Marked out of 10 Up to 5 for approach, aids, quiet hands, straight for center pole Up to 5 for position and balance over pole Total 10 for Jump Faults for knock down, refusal and wrong course to be deducted from total marks for jumps		
	Marks	
	Deductions	
	Total Points	



Judge's Name: \_\_\_\_\_

Judge's Signature: \_\_\_\_\_

**13. ENGLISH EQUITATION**

Event	CS	CI	BS	BI	A
English Equitation	Yes	Yes	Yes	Yes	Yes

**13.1 General Information**

- 13.1.1 English Equitation is obligatory as a preliminary test after horse matching and practicing.
- 13.1.2 English Equitation is also one of the optional equestrian events.
- 13.1.3 The judge located at the arena gives commands to the riders.
- 13.1.4 At the World Games, the commands are given in the rider's native language by either the coach or a person appointed by the coach. The commands must be an exact translation of the judge's words, without any additional comments. An interpreter may be present next to the person giving the commands.
- 13.1.5 No set test is used. It is up to judge to ask for what they would like to see rider doing to enable a mark for movement as specified on judges sheet.

**13.2 Class Routines and Expectations**

- 13.2.1 Riders will perform the gaits appropriate for the division they are entered in.
- 13.2.2 Riders may be required to execute any appropriate tests as determined by the judges and the event director.
- 13.2.3 Any or all riders may be required to execute appropriate tests included in the class requirements. Tests may be performed either collectively or individually.
- 13.2.4 All tests must be on the flat.
- 13.2.5 Judges are encouraged to call for at least three tests to be performed.
- 13.2.6 Riders will be judged on seat, aids and the ability to control the horse. Results as shown by the performance of the horse are not to be considered more important than the method used by the rider.
- 13.2.7 Competitors enter the ring at the gait called for by the judge.
- 13.2.8 Riders will be expected to ride in both directions around the ring, either individually or as a group, as called for by the judge. In the posting trot, riders are expected to be on the correct diagonal. They will not canter as a group for safety reasons.

**13.3 English Equitation Tests—Judges may choose from the following tests:**

- 13.3.1 Riders will perform the gaits appropriate for the division they are entered in. Work collectively at the walk, trot or canter.
- 13.3.2 Transitions:  
 In some cases, when the athlete makes an "error of the course", the sounding of the bell might unnecessarily impede the fluency of the performance. In these instances, it is at the judge's discretion whether to sound the bell or not.
  - 13.3.2.1 C Level—Walk
  - 13.3.2.2 B Level—walk/trot/walk
  - 13.3.2.3 A Level— walk/canter/trot
- 13.3.3 Halt (4-6 seconds) from the walk or trot
- 13.3.4 Small circle (10m) at the walk or trot.



- 13.3.5 Large circle (20m) at the trot or canter
- 13.3.6 Figure-8 at the walk or trot. (circles between 6–15m)
- 13.3.7 Diagonal lines at the walk or trot.
- 13.3.8 Reverse direction by a half circle (6m) at the walk or trot.
- 13.3.9 Serpentine at the posting trot showing a change of diagonals (for A level riders).
- 13.3.10 Change leads at the trot, demonstrating a simple or interrupted change of leads.
- 13.3.11 Figure-8 at the canter (circles between 15–20m), demonstrating the correct lead on the circles with a simple change of lead as the rider moves from circle to circle. The canter change will be over trot.



**EQUITATION JUDGES FORM LEVEL A WALK, TROT CANTER**

Competition : \_\_\_\_\_  
 Division : \_\_\_\_\_  
 Level: \_\_\_\_\_

Date:-

Athlete Details	Walk	Trot	Canter	Halt	Transitions	Circle	Use of Aids	Seat and Balance	Ability to Control and show Horse	Total	Place
No# _____											
Horse: _____											
No# _____											
Horse: _____											
No# _____											
Horse: _____											
No# _____											
Horse: _____											

**EACH MOVEMENT IS MARKED OUT OF 10**

Judges Name : \_\_\_\_\_  
 Judges Signature : \_\_\_\_\_



**EQUITATION JUDGES FORM LEVEL BS AND BI TROT ON LEAD TROT OFF LEAD**

Competition : \_\_\_\_\_

Division : \_\_\_\_\_

Level: \_\_\_\_\_

Date:-

Athlete Details		Walk	Trot	Halt	Transitions	Circle	Use of Aids	Seat and Balance	Ability to Maintain Paces	Total	Place
No#											
Horse:											
No# 11											
Horse:											
No#											
Horse:											
No#											
Horse:											

EACH MOVEMENT IS MARKED OUT OF 10

Judges Name : \_\_\_\_\_

Judges Signature : \_\_\_\_\_





**EQUITATION JUDGES FORM LEVEL CS AND CI WALK ON LEAD AND WALK OFF LEAD**

Competition : \_\_\_\_\_

Division : \_\_\_\_\_

Level: \_\_\_\_\_

Date:-

Athlete Details		Walk	Free Walk	Halt	Transitions	Circle	Use of Aids	Seat and Balance	Ability to Control and show Horse	Total	Place
No#											
Horse:											
No#											
Horse:											

**EACH MOVEMENT IS MARKED OUT OF 10**

Judges Name : \_\_\_\_\_

Judges Signature : \_\_\_\_\_



**14. ENGLISH WORKING TRAILS**

Event	CS	CI	BS	BI	A
Trail	Yes	Yes	Yes	Yes	Yes

14.1 General Information

- 14.1.1 Trail horses are required to work over and through obstacles.
- 14.1.2 No horse may enter the trail course area until the course and the judge are ready.
- 14.1.3 Riders will be permitted to inspect the course on foot during the Judge’s instructions prior to the start of the class.
- 14.1.4 Course designers should keep in mind that all courses and obstacles are to be constructed with safety in mind so as to reduce the potential for accidents.
- 14.1.5 Judges must walk the course before competition. The judges have the right/duty to alter the course in any manner or to remove or change any obstacle deemed unsafe or non-negotiable.
- 14.1.6 Safety of the gaits between obstacles is at the discretion of the judges.
- 14.1.7 The course should be designed to require each horse to show all gaits appropriate to its division.
- 14.1.8 Enough space must be provided for the horse to trot at least 10m (30') and canter at least 15m (50') for the judge to evaluate these gaits in the appropriate divisions.
- 14.1.9 Outdoor facilities are encouraged to include natural obstacles (i.e. trees, creeks, brush, hills, ditches, etc.) in the course as long as these obstacles can be maneuvered safely and are in easy access and view of the judge.
- 14.1.10 Conservative colored bandages and boots on the horse’s legs are permitted in Trail classes only
- 14.1.11 Required Obstacles:
  - 14.1.11.1 Riders in Divisions A
    - The course should include three elements from the list of mandatory obstacles and at least three from the optional list.
    - The course should contain a minimum of six elements and a maximum of ten.
  - 14.1.11.2 Riders in Divisions CI and BI
    - The course should include three elements from the list of mandatory obstacles.
    - The course should contain a minimum of five elements and a maximum of seven.
  - 14.1.11.3 Riders in Divisions CS and BS
    - The course should include two elements from the list of mandatory obstacles.
    - The course should contain a minimum of four elements and a maximum of six.



## 14.2 Judging

- 14.2.1 Each entry will be judged on the rider's ability to guide the horse through a designated course. Credit will be given to horses negotiating the obstacles correctly while responding to the rider's cues.
- 14.2.2 If a horse takes an excessive amount of time at an obstacle, the judge is encouraged to advance that horse to the next obstacle. Horses should be penalized for any unnecessary delay in approaching an obstacle.
- 14.2.3 Off course is defined as:
- 14.2.3.1 Taking an obstacle in the wrong direction or from the wrong side.
  - 14.2.3.2 Taking an obstacle in a manner other than described in the pattern.
  - 14.2.3.3 Skipping an obstacle, unless directed by the judge.
  - 14.2.3.4 Negotiating obstacles in the wrong sequence.
  - 14.2.3.5 Failure of the rider to attempt an obstacle as directed by the judge.

## 14.3 English Trail Elements

### 14.3.1 Unacceptable Obstacles

- 14.3.1.1 Tires
- 14.3.1.2 Animals (alive or dead)
- 14.3.1.3 Hides
- 14.3.1.4 Remounting after dismounting
- 14.3.1.5 Jumps
- 14.3.1.6 Rocking, floating or moving bridges
- 14.3.1.7 Flames, dry ice, fire extinguishers, etc.
- 14.3.1.8 Logs or poles elevated in a manner that causes them to roll

### 14.3.2 Mandatory Obstacles

- 14.3.2.1 Ride over at least 4 logs or poles
- 14.3.2.1.1 Poles can be in a straight, curved or zigzag line.
  - 14.3.2.1.2 The space between poles is to be measured on the path the horse is to take:
    - Ground poles for walk (not elevated)—spaced a minimum of 40-50cm (15–20") apart.
    - Ground poles for walk (elevated)—spaced a minimum of 56cm (22") apart and may be elevated a maximum of 30cm (12") measured from the ground to the top of the element.
    - Ground poles for trot (not elevated)—spaced a minimum of 90-107cm (3'–3'6") apart.
    - Ground poles for canter (not elevated)—spaced a minimum of 2m (6–7') apart.
- 14.3.2.2 Serpentine obstacles at a walk or trot.
- 14.3.2.2.1 Obstacles may include:
    - Orange safety cones
    - Stakes 2m (6'6") high, made of plastic, wood or other suitable, safe materials, set in a base constructed so as not to interfere with the horse's path
    - Barrels or quarter drums
    - Plants in safe tubs or planters
    - Natural obstacles such as trees and bushes that are trimmed high enough so as not to be a safety hazard for the athletes
- 14.3.2.3 Spacing should be a minimum of:





**EQUITATION JUDGES FORM LEVEL CS AND CI WALK ON LEAD AND WALK OFF LEAD**

Competition : \_\_\_\_\_

Division : \_\_\_\_\_

Level: \_\_\_\_\_

Date:-

Athlete Details		Walk	Free Walk	Halt	Transitions	Circle	Use of Aids	Seat and Balance	Ability to Control and show Horse	Total	Place
No#											
Horse:											
No#											
Horse:											

**EACH MOVEMENT IS MARKED OUT OF 10**

Judges Name : \_\_\_\_\_

Judges Signature : \_\_\_\_\_



**15. WESTERN EVENTS SECTION**

15.1 Stock Seat Equitation

15.1.1 General Information

- 15.1.1.1 Any or all riders may be required to execute appropriate tests included in the class requirements. Tests may be performed either collectively or individually.
- 15.1.1.2 Individual patterns consisting of a combination of elements may be called for.
- 15.1.1.3 Judges are encouraged to call for at least two tests to be performed.
- 15.1.1.4 Riders will not be asked to change horses.
- 15.1.1.5 Instructions must be publicly announced. It is recommended that written pattern instructions be included in the Coaches Handbook or be posted a minimum of one hour prior to competition.

15.1.2 Class Routines and Expectations

- 15.1.2.1 Competitors enter the ring at a walk or jog and are judged on the rail at a flat-footed four beat walk, a two beat jog and a three beat lope in accordance with the division specifications.
- 15.1.2.2 Competitors then line up and back their horses on command.
- 15.1.2.3 At the lope, horses are expected to be on the correct lead.

15.1.3 Stock Seat Equitation Tests—Judges may choose from the following tests:

- 15.1.3.1 Large circle at the walk or jog
- 15.1.3.2 Halt
- 15.1.3.3 Reverse direction from a halt, walk, or jog
- 15.1.3.4 Lope stops
- 15.1.3.5 Roll back, haunch turns or spins
- 15.1.3.6 Figure 8 at a jog
- 15.1.3.7 Figure 8 at a lope on the correct lead, demonstrating a simple, interrupted or flying change
- 15.1.3.8 Change of leads down the center of the ring demonstrating at least 3 changes of lead

15.1.4 Stock Seat Equitation Chart

Guidelines Only				Mandatory
	Good	Minor Faults	Major Faults	Elimination
<b>Seat</b>	Keeping center of balance Complete contact with saddle Straight Back	Sitting off center Sway back Round back Losing center of balance	Excessive body motion Popping out of saddle	At judges discretion Fall to the ground of horse or rider
<b>Hands</b>	Quiet light hands Maintaining consistent head position	Unsteadiness Restrictions causing untrue gaits	Horse’s mouth gaping Heavy hands Constant bumping	At judges discretion Fall to the ground of horse or rider



<b>Legs</b>	Secure leg position Proper weight in stirrups Controlling motion Weight evenly on ball of foot Heels lower than toes	Uneven stirrups Motion in legs Insufficient weight in stirrups	Interfering with another rider Excessive spurring Loss of contact between legs & saddle foot & stirrup Coming in contact with fence or other riders	At judges discretion Fall to the ground of horse or rider
<b>Control</b>	Maintaining horse in good form at consistent gaits Ability to maintain horse under adverse conditions	Breaking from walk to jog Breaking from jog to lope Not standing in line up	Breaking from jog to walk Breaking from lope to jog Allowing horse to back crooked Missing leads	At judges discretion Fall to the ground of horse or rider
<b>Overall Appearance</b>	Suitable well-fitted outfit Well-groomed horse Clean equipment	Saddle not suitable to rider's size Unfitted outfit Dirty boots	Unclean equipment Ungroomed horse Untrimmed horse	At judges discretion Fall to the ground of horse or rider
<b>General</b>	Good attitude towards horse and judge Consistency of riders form	Equipment not fitting horse Failure to use corners and rail Suitability of horse and rider	Excessive voice commands Excessive circling Major delays in transitions	At judges discretion Fall to the ground of horse or rider

15.2 Western Riding

15.2.1 General Information

- 15.2.1.1 This contest is neither a stunt nor a race, but should be performed with reasonable speed.
- 15.2.1.2 Western riding is a competition in the performance and characteristics of a good, sensible, well-mannered, free and easy moving horse.
- 15.2.1.3 Horses will be judged on riding qualities of the gaits and change of lead (simple, interrupted or flying), and the athlete's ability to influence the horse.
- 15.2.1.4 All Special Olympics tests may be called/read. (See rules on calling tests under Dressage.)
- 15.2.1.5 The judge will select the pattern to be performed at the appropriate level. The judge is responsible for the pattern being correctly set.

15.2.2 Facilities and Set-up

- 15.2.2.1 The markers in the arena must be a minimum of 9.14m (30') and a maximum of 15.24m (50') apart on the sides, using 5 markers. (See Test diagrams below)
  - 15.2.2.1.1 In all patterns, markers must be in line with appropriate markers on the opposite side.
  - 15.2.2.1.2 Markers should be a minimum of 4.7m (15') from the wall.
  - 15.2.2.1.3 The pattern width should be a minimum of 15.24m (50') and a maximum of 24.38m (80'), as the arena permits.
- 15.2.2.2 A solid log or pole, a minimum of 2.44m (8') in length, should be used.

15.2.3 Judging: Riders will be evaluated on:

- 15.2.3.1 Ability to guide the horse through the designated course
- 15.2.3.2 Ability to maintain consistent gait and smooth transitions in change of gait and direction





## 15.2.3.3 General attitude

## 15.2.3.4 Using only one hand on the reins

## 15.2.3.5 Keeping hands clear of the horse and saddle while the horse is in motion

Credit will be given for the emphasis placed on smoothness, even cadence of gaits and the horse's ability to change leads precisely and easily (rear and front) at the center point between markers. The horse should cross the log without breaking gait or radically changing stride.

## 15.2.4 Scoring: Riders will be scored from 0-100, with 70 denoting an average performance.

## 15.2.4.1 Points will be added or subtracted for the maneuvers on the following basis, ranging from plus 1.5 to minus 1.5.

## Minus:

1.5	Extremely Poor
1.0	Very Poor
0.5	Poor
0.0	Average

## Plus:

0.5	Good
1.0	Very Good
1.5	Excellent

## 15.2.4.1.1 Maneuver scores are to be determined independently of penalty points. The following characteristics are considered faults and should be judged accordingly in maneuver scores:

- Horse opening mouth excessively
- Horse anticipating signals or changing leads early
- Horse stumbling

## 15.2.4.2 A competitor will be penalized each time the following occur:

## 15.2.4.2.1 Five Points

- Failure to change leads
- Kicking out
- Blatant disobedience

## 15.2.4.2.2 Three Points

- Not performing the specific gait (jog or lope) or not stopping within 3m (10') of the designated area called for in the pattern
- Break of gait at the lope
- Additional repeating of movements by the caller/reader
- Failure to change leads after one stride, but does complete the lead change before the next designated change area
- Additional lead changes anywhere in the pattern
- In Pattern One, Division A: Failure to start the lope within 30 feet after crossing the log at the jog
- In Pattern One, Division B: Failure to start the jog within 20 feet after crossing the centerline
- Break of gait at the walk or jog for two or more strides

## 15.2.4.2.3 One Point

- Break of gait at the walk or jog for up to two strides
- Hitting or rolling the log
- Failure to change leads for one stride
- Splitting the log (log between the front and two hind feet) at the lope

## 15.2.4.2.4 One-Half Point

- Tick or light touch of the log



- b) Hind legs skipping or coming together during lead change
- c) Failure to change leads from 1/2 to 1 stride
- 15.2.4.2.5 A competitor will be disqualified (0 score) for:
  - a) Illegal equipment or willful abuse b) Off course
  - c) Knocking over markers
  - d) Completely missing log
  - e) Major refusal—Stop and back 2 strides or 4 steps with front legs
  - f) Major disobedience—rearing, etc.
  - g) Fall to the ground by horse or rider
  - h) Unauthorized assistance, except for safety
- 15.2.4.2.6 A competitor will receive credits for:
  - a) Changes of leads, hind and front legs simultaneously
  - b) Changes of leads at designated point
  - c) Accurate and smooth pattern
  - d) Even pace throughout
  - e) Horse appearing easy to guide and control with rein and leg aids
  - f) Manners and disposition

15.2.5 Division A—Test 1

Enter. Proceed at a walk

- H Jog
  - K Jog over log and immediately lope
  - M Turn left across arena
  - F Weave the stakes, changing lead after each stake
  - A Lope across the arena
  - H Bend H and cross arena, changing lead at centerline
  - B Bend B and cross arena, changing lead at centerline
  - K Lope over log and cross arena, changing lead at centerline
  - E Bend E and cross arena, changing lead at centerline
  - M Bend M and then turn down centerline between C and K. On centerline, halt and back.
- Proceed to judge for dismissal.

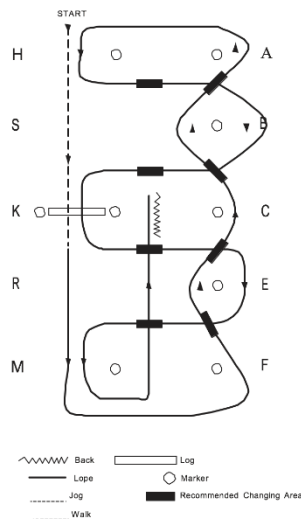



15.2.6 Division A—Test 2

- A Walk. Bend A right and jog across arena over log. Lope.
  - S Bend S left and cross arena, changing lead at centerline.
  - C Bend C right and cross arena, changing lead at centerline.
  - R Bend R left and cross arena, changing lead at centerline.
  - F Circle F right, then weave letters to A, changing leads after each letter.
  - A Circle A right, then cross arena and lope over log between H and S. Halt and back.
- Proceed to judge for dismissal.

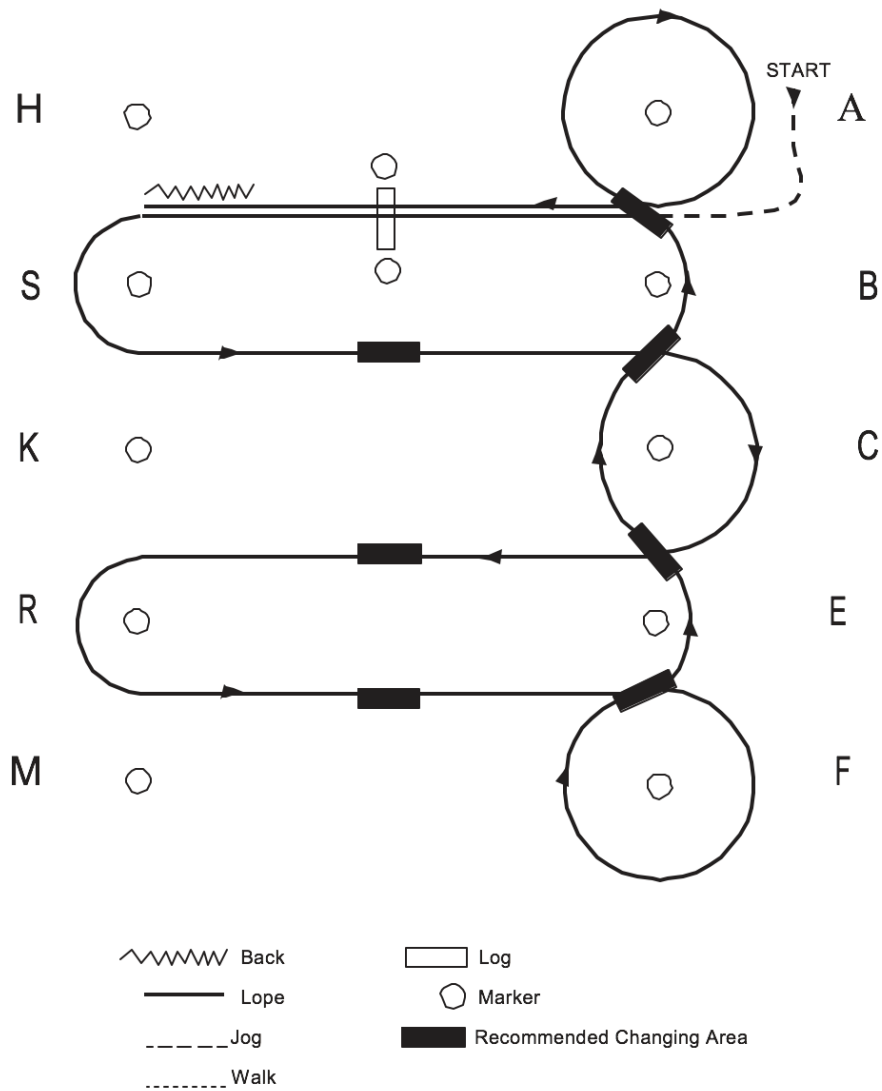

15.2.7 Division B—Test 1

- Enter. Proceed at walk.
- H Walk.
- K Walk over log and turn left across arena. Jog at centerline.
- C Bend and then jog. Weave to A.



- A Cross arena at a jog.
- H Bend H and cross arena at a jog.
- B Bend B and cross arena at a jog.
- K Bend K, crossing over log. Turn down centerline. Between A and H, halt and back. Proceed to judge for dismissal.

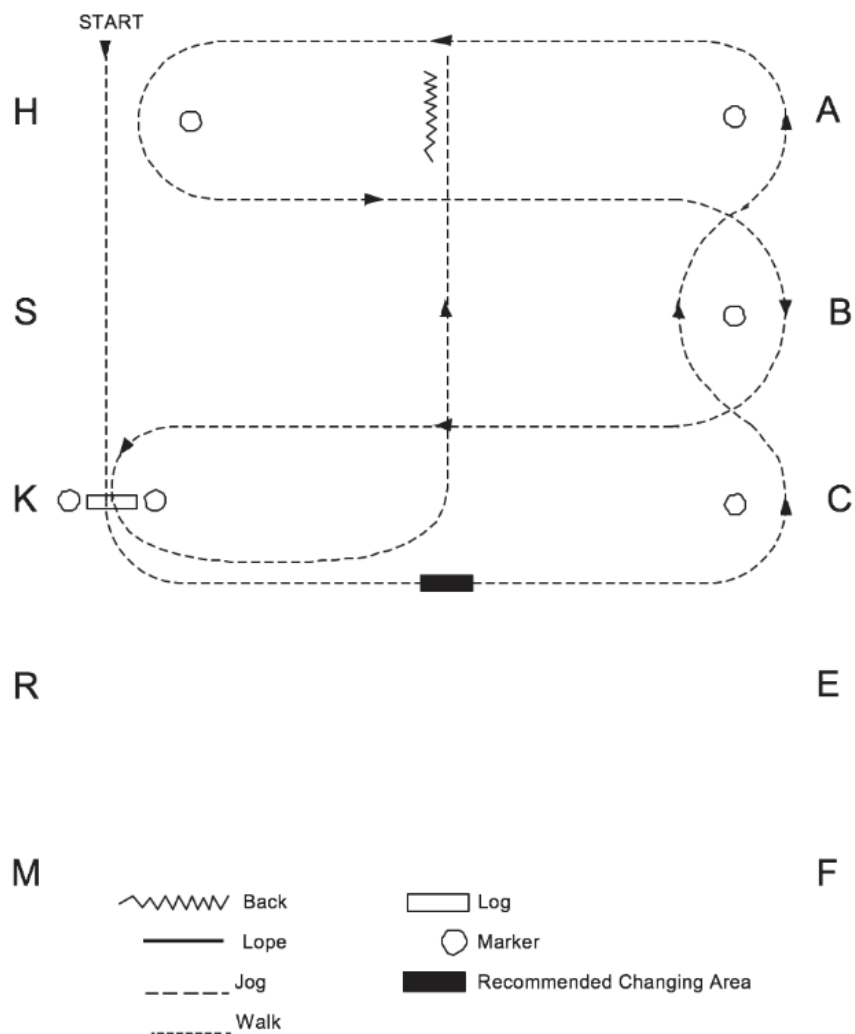



## 16. WESTERN WORKING TRAILS

Event	CS	CI	BS	BI	A
Trail	Yes	Yes	Yes	Yes	Yes

### 16.1 General Information

- 16.1.1 Course designers should keep in mind that all courses and obstacles are to be constructed with safety in mind so as to eliminate any accidents.
- 16.1.2 Judges must walk the course before competition. The judges have the right/duty to alter the course in any manner or to remove or change any obstacle deemed unsafe or non-negotiable.
- 16.1.3 Safety of the gaits between obstacles is at the discretion of the judges.
- 16.1.4 Management is encouraged to design obstacles that can be safely negotiated in 90 seconds.
- 16.1.5 The course should be designed to require each horse to show all gaits appropriate to its division.
- 16.1.6 Enough space must be provided for the horse to trot at least 10m (30') and canter at least 15m (50') for the judge to evaluate these gaits in the appropriate divisions.
- 16.1.7 Outdoor facilities are encouraged to include natural obstacles (i.e. trees, creeks, brush, hills, ditches, etc.) in the course as long as these obstacles can be maneuvered safely and are in easy access and view of the judge.
- 16.1.8 Conservative colored bandages and boots on the horse's legs are permitted in Trail classes only.
- 16.1.9 Required Obstacles:
- 16.1.9.1 Riders in Divisions A
- 16.1.9.1.1 The course should include three elements from the list of mandatory obstacles and at least three from the optional list.
- 16.1.9.1.2 The course should contain a minimum of six elements and a maximum of ten.
- 16.1.9.2 Riders in Divisions CI and BI
- 16.1.9.2.1 The course should include three elements from the list of mandatory obstacles.
- 16.1.9.2.2 The course should contain a minimum of five elements and a maximum of seven.
- 16.1.9.3 Riders in Divisions CS and BS
- 16.1.9.3.1 The course should include two elements from the list of mandatory obstacles. b) The course should contain a minimum of four elements and a maximum of six.

### 16.2 Judging

- 16.2.1 Each entry will be judged on the rider's ability to guide the horse through a designated course. Credit will be given to horses negotiating the obstacles correctly while responding to the rider's cues. If a horse takes an excessive amount of time at an obstacle, the judge is encouraged to advance that horse to the next obstacle.
- 16.2.2 Horses should be penalized for any unnecessary delay in approaching an obstacle.
- 16.2.3 Off course is defined as:
- 16.2.3.1 Taking an obstacle in the wrong direction or from the wrong side.
- 16.2.3.2 Taking an obstacle in a manner other than described in the pattern.



16.2.3.3 Skipping an obstacle, unless directed by the judge.

16.2.3.4 Negotiating obstacles in the wrong sequence.

16.2.3.5 Failure of the rider to attempt an obstacle as directed by the judge.

16.2.4 For errors of the course, the rider will receive no score for that obstacle, but will not necessarily be eliminated from the class. Those riders having errors of the course should place below riders who follow the prescribed course.

**WESTERN TRAIL JUDGING GUIDELINES**

	Guidelines Only			Mandatory
Trail	Good	Minor Faults	Major Faults	Elimination
<b>Walk</b> <b>Jog/Trot</b> <b>Lope/Canter</b> (on the course)	Consistency of gait  Clear transitions	Inconsistency of gait  Wrong lead at lope or canter	Break of gait  Failure to perform gait called for	At judges' discretion  Fall to the ground of horse or rider
<b>Control Obstacles</b>  Gates Back thru Side passes Turns on forehand and hindquarters Serpentine	Smooth Good position Responsive	Slight touches Slant side passes Wide positions Slow response Backing crooked	Knock down elevated elements  Stepping out of confining elements  Losing gait  Fussiness and extreme tension Refusals	At judges' discretion  Fall to the ground of horse or rider
<b>Agility Obstacles</b>  Walk overs Trot or lope Cavaletti Bridges	Attentive  Careful Willing Low poll	Slight touches  Too hesitant  Failure to stay on center lines	Knock downs  Refusals Failure to maintain gaits  Off side of bridge	At judges' discretion  Fall to the ground of horse or rider
<b>Calmness Obstacles</b>  Plastic Brush Plants Carrying objects	Steady going  Alert Careful but willing Low poll Calm when carrying objects	Tense over or thru obstacles  Spooking when carrying objects	Jumping over or stampeding thru obstacles  Refusals	At judges' discretion  Fall to the ground of horse or rider

All horses with clean or minor faults trips will be considered before major fault horses

**16.3 Western Trail Elements**

**16.3.1 Unacceptable Obstacles**

16.3.1.1 Tires

16.3.1.2 Animals (alive or dead)

16.3.1.3 Hides

16.3.1.4 Remounting after dismounting

16.3.1.5 Jumps

16.3.1.6 Rocking, floating or moving bridges

16.3.1.7 Flames, dry ice, fire extinguishers, etc.

16.3.1.8 Logs or poles elevated in a manner that causes them to roll

**16.3.2 Mandatory Obstacles**



- 16.3.2.1 Passing through a gate. The gate should be approximately 1.53m (5') high and have a latch at that height.
- 16.3.2.2 Ride over at least 4 logs or poles.
- 16.3.2.2.1 Poles can be in straight, curved or zigzag line.
- 16.3.2.2.2 The space between poles is to be measured on the path the horse is to take:
- Ground poles for walk (not elevated) spaced a minimum of 40-50cm (15-20") apart.
  - Ground poles for walk (elevated) spaced a minimum of 56cm (22") apart and may be elevated a maximum of 30cm (12") measured from the ground to the top of the element.
  - Ground poles for jog (not elevated) spaced a minimum of 90-107cm (3'-3'6") apart.
  - Ground poles for lope (not elevated) spaced a minimum of 2m (6-7') apart.
- 16.3.2.3 Backing obstacles.
- 16.3.2.3.1 Obstacles should be spaced a minimum of 70cm (28") apart or, if elevated, a minimum of 75cm (30") apart.
- 16.3.2.3.2 Obstacle poles may be elevated no more than 60cm (24") and must be set in standard jump cups or similar type cups.
- 16.3.2.3.3 Obstacles may include the following:
- Walk in and back out of a straight chute (recommended for beginning athletes). ii. Back through and around at least 3 markers.
  - Back through L,V, U, straight or similar shaped courses.
- 16.3.3 Optional Obstacles
- 16.3.3.1 Ride through serpentine obstacles at a walk, jog or lope.
- 16.3.3.1.1 Obstacles may include:
- Orange safety cones
  - Stakes 2m (6'6") high, made of plastic, wood or other suitable, safe materials, set in a base constructed so as not to interfere with the horse's path
  - Barrels or quarter drums
  - Plants in safe tubs or planters
  - Natural obstacles such as trees and bushes that are trimmed high enough so as not to be a safety hazard for the athletes
- 16.3.3.1.2 Spacing should be a minimum of:
- 2m (6-7') for the walk
  - 3m (9-10') for the jog
  - 10m (33') for the lope
- 16.3.3.1.3 When designing a course for assisted riders, the course designer must remember to include adequate space for the sidewalkers.
- 16.3.3.2 Carry an object from one part of the arena to another. Plastic bags and metal cans should not be used.
- 16.3.3.3 Ride over a wooden bridge.
- 16.3.3.3.1 Bridge must be sturdy.
- 16.3.3.3.2 Bridge must be a minimum of 1m (36") wide and a minimum of 1.83m (6') long.





- 16.3.3.3.3 Suggested ridge is a piece of 3/4" plywood laid directly on the ground. Recommended dimensions: 1.22m (4') by 2.44m (8')
- 16.3.3.4 Put on and remove a slicker, coat, vest, etc.
- 16.3.3.5 Remove and replace materials in a mailbox.
- 16.3.3.6 Side pass.
  - 16.3.3.6.1 Elements may be elevated a maximum of 30cm (12")
  - 16.3.3.6.2 Elements are a minimum of 1.06m (3'6") apart if all 4 hooves of the horse are within the obstacle; a minimum of 51cm (20") apart if only the front hooves are within the obstacle; or 61cm (24") if only the hind hooves are within the obstacle.
  - 16.3.3.6.3 Side pass may be through L,T,V,Z or straight paths and may include:
    - Haunch or forehand turns
    - Confined space (path) for front hooves, hind hooves, or all 4 hooves
- 16.3.3.7 Ride into a square consisting of 4 logs (rails) a minimum of 1.53m (5') long. The athlete will enter the square over a designated log, execute any maneuver as indicated and depart over a designated log.
- 16.3.3.8 Pass between 2 sawhorses of standard dimensions with solid ends. The sawhorses should be 1.83m (6') apart. Each sawhorse should be draped with a saddle blanket.
- 16.3.3.9 Ride through or under brush.
- 16.3.3.10 Guide horse through an L, V or Z pattern of ground poles.
- 16.3.3.11 Ride into or out of a ditch without lunging or jumping.
- 16.3.3.12 Negotiate any safe obstacle which could be encountered on trail rides. (In designing these obstacles, figure the horse's wheelbase to be 1.53m. or 5', from front hooves to back hooves). The approval of the judge is mandatory for these obstacles.
- 16.3.3.13 Ride through a combination of two or more obstacles.

Trot-overs, Lope-overs and Walk-over Diagram

Variations of Sidepass Diagrams (4 diagrams)

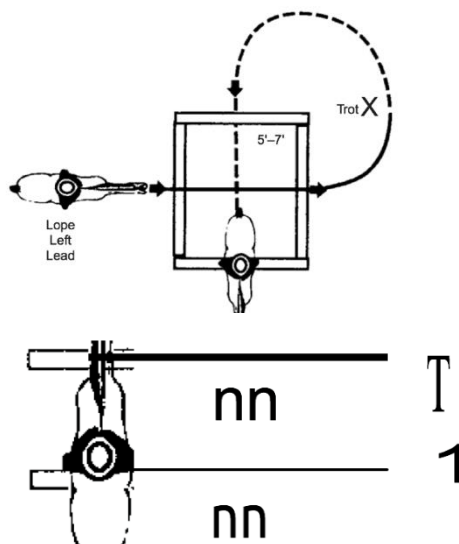

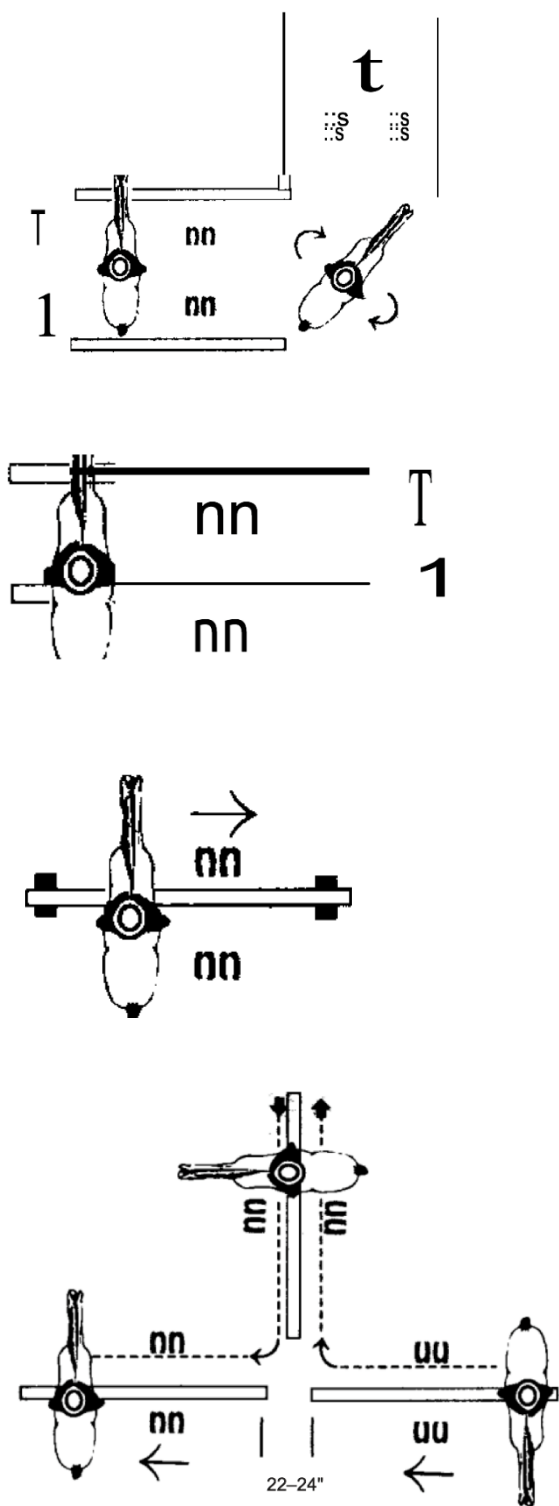

Variations of L Back Through Diagram

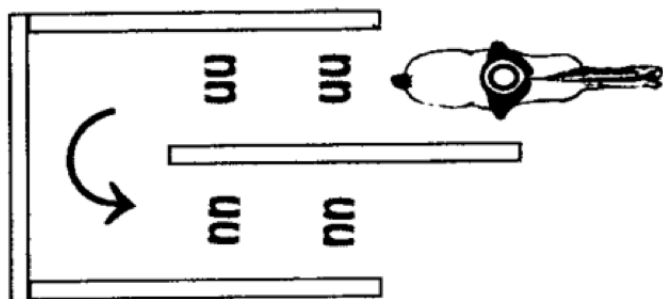
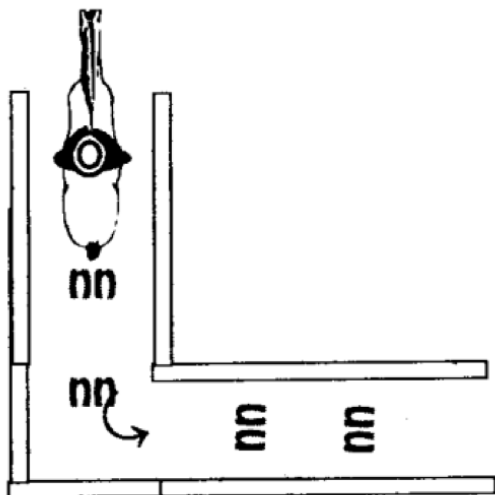



Variations of Back Through and Around Three Markers Diagrams

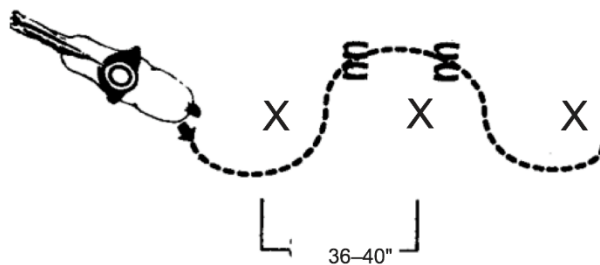
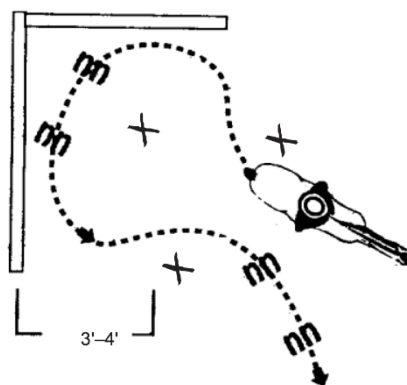
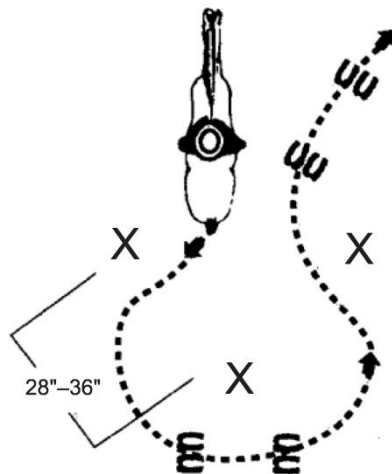

Variations of Back Through and Around Three Markers Diagrams

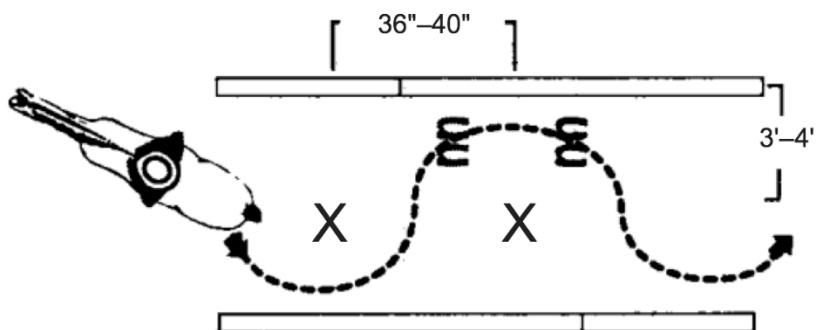

Trot Over Poles

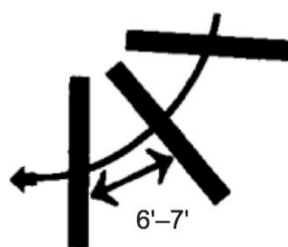

Lope Over Poles

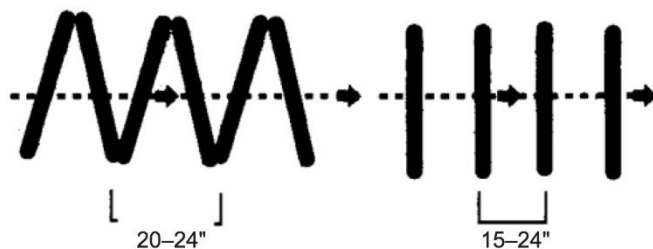

Pick Way Through

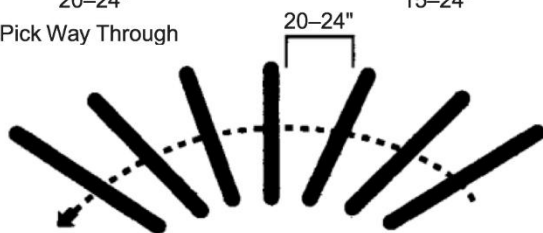

Curved

**17. ENGLISH AND WESTERN EVENTS: Section B: Showmanship**

17.1 General Information



- 17.1.1 The emphasis in the Showmanship class should be on the athlete's ability to handle and show the horse, with safety as the main consideration. The horse is merely a prop to show the ability of the showman.
- 17.1.2 Athletes showing horses under Western Tack Style may use a halter and lead shank made of leather or nylon. Chain leads are acceptable. Western attire, including an approved safety helmet, is appropriate.
- 17.1.3 Athletes showing horses under English Tack Style may use a suitable English bridle or halter of either leather or nylon. (See English Equitation rules for acceptable bridles.) English attire, including an approved safety helmet, is appropriate.
- 17.1.4 The Quarter method of showmanship will be used. The following suggested guidelines of movement are meant to serve as an illustration of movement around the horse while showing in Showmanship classes and are for the exhibitors'/coaches' information.
  - 17.1.4.1 Imaginary lines bisect the horse into 4 equal parts, as seen in the figure. (Note: The quadrants will be numbered I, II, III and IV for ease of identification).
    - 17.1.4.1.1 One line runs across the horse just behind the withers.
    - 17.1.4.1.2 The other imaginary line runs from head to tail.
  - 17.1.4.2 The athlete should move around the horse in the following manner:
    - 17.1.4.2.1 When the judge is in I, the handler should be in IV.
    - 17.1.4.2.2 As the judge moves to II, the handler should move to I.
    - 17.1.4.2.3 When the judge moves to III, the handler moves to IV.
    - 17.1.4.2.4 As the judge moves up the horse to IV, the handler returns once more to I.
  - 17.1.4.3 This method of showmanship is based on safety, as the handler can keep the horse's hindquarter from swinging toward the judge should the horse become fractious.
- 17.1.5 Show management must post individual test patterns a minimum of one hour before the class is to be held.
- 17.1.6 The following maneuvers are considered acceptable elements for individual test patterns:
  - 17.1.6.1 Lead the horse at a walk or jog/trot
  - 17.1.6.2 Back in a straight or curved line
  - 17.1.6.3 Halt
  - 17.1.6.4 Pivot or turn—quarter, half or full (360 degrees)
  - 17.1.6.5 Set up square

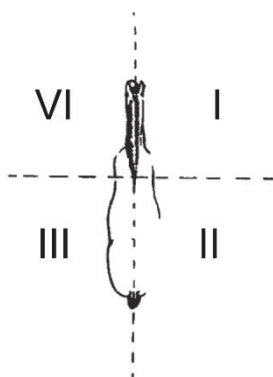

## 17.2 Class Routine



- 17.2.1 Enter the arena in a counter clockwise direction (unless otherwise directed by the judge), leading the horse at an alert walk. Note: The horse should lead readily at the walk or trot.
  - 17.2.2 After the class has been lined up, the judge will call on each exhibitor to move his/her horse individually. When moving the horse, be sure the judge gets a clear, unobstructed view of the horse's action.
- 17.3 Judging
- 17.3.1 Appearance of the horse and exhibitor: 20 points
    - 17.3.1.1 Grooming of the horse
      - 17.3.1.1.1 Clean, well brushed hair coat (Dust and stains are objectionable).
      - 17.3.1.1.2 Areas which must be clean: around the eyes, ears, muzzle, nostrils, between the legs and around the tail.
      - 17.3.1.1.3 Mane, tail, forelock and wither tufts must be clean and free of tangles. It is prohibited to use any ornaments on the aforementioned. Manes, forelocks, and wither tufts may be English or Western braided if the exhibitor so desires.
    - 17.3.1.2 Trimming of the horse
      - 17.3.1.2.1 Manes may be roached, but the forelock and wither tufts must be left.
      - 17.3.1.2.2 The inside of the ears may be clipped.
      - 17.3.1.2.3 Long hair on the jaw, legs and pasterns should be clipped.
    - 17.3.1.3 Tack
      - 17.3.1.3.1 Tack should be neat, clean and in good repair.
      - 17.3.1.3.2 Horses shown Western must be in a halter of nylon or leather.
      - 17.3.1.3.3 Horses shown English may be in either a bridle or halter of leather or nylon
    - 17.3.1.4 Appearance of the exhibitor
      - 17.3.1.4.1 Clothes and person—neat and clean.
      - 17.3.1.4.2 Appropriate Western tack-style clothes.
      - 17.3.1.4.3 Appropriate English tack-style clothes. Jackets are optional.
  - 17.3.2 Showing the horse in the ring: 60 points
    - 17.3.2.1 Leading: 40 points
      - 17.3.2.1.1 The athlete should lead from the left side of the horse with the lead shank/reins held in the right hand about
        - 17.3.2.1.2 2–3cm (8–12") from the halter/bit. (Smaller athletes may need a longer hold.) The athlete should not hold the chain part of the shank. It is at the judge's discretion whether to penalize for this.
        - 17.3.2.1.3 The athlete should stay in position by the left side of the horse's head, "eye to eye" with the horse. The athlete should not touch the horse with his/her hands or feet.
        - 17.3.2.1.4 Excess lead shank/rein should be held safely and neatly in the left hand. A tightly coiled/rolled lead shank or reins wrapped around the athlete's left hand will be cause for points to be deducted from the athlete's score.
        - 17.3.2.1.5 A loose, flapping lead shank or rein will be considered a fault.
        - 17.3.2.1.6 Emphasis should be placed on the light control of the horse with a minimum of pressure on the lead shank/reins, to allow the horse to hold its head naturally. The horse should move out and continue readily, freely and quietly at the walk and jog/trot, with a minimum of urging by the athlete.
        - 17.3.2.1.7 It is permissible for the athlete to pass between the horse and the judge as the judge moves around the animal, but the athlete should avoid blocking



the judge's view beyond the movement required to step between the horse and the judge. The athlete should step quickly and quietly to the zone where both horse and judge can be observed.

- 17.3.2.1.8 All pivot turns of 90 degrees or larger should be executed to the right.
- 17.3.2.1.9 It is to be remembered that the athlete is also being judged on safety. The athlete should not crowd the competitor next to him/her when positioned in a side by side line up or in front of him/her when lined up head to tail.
- 17.3.2.1.10 If the judge or ringmaster requests a change in position, the athlete should first look around to see that the nearby competitors have their horses under control, then move out promptly as indicated.
- 17.3.2.2 **Posing: 20 points**
  - 17.3.2.2.1 When posing the horse, the athlete should stand facing, but not directly in front of, the horse. The athlete should always be in a position where he/she can keep an eye on the judge.
  - 17.3.2.2.2 The athlete should pose the horse with his feet squarely under him, using the lead shank/reins to achieve the pose, never kicking a horse's leg into position.
  - 17.3.2.2.3 When the judge is observing other horses, the athlete should let his/her horse stand if it is posed reasonably well.
  - 17.3.2.2.4 The athlete should be natural. Over showing, undue fussing and maneuvering are objectionable.
- 17.3.3 **Poise alertness and merits: 20 points**
  - 17.3.3.1 Athlete's awareness of the position of the judge at all times.
  - 17.3.3.2 Athlete shows the horse at all times and is not distracted by persons and things outside of the ring. He/she shows the entire time, until the class has been placed and excused from the ring.
  - 17.3.3.3 Athlete remains attentive for any instructions from the judge or ringmaster and cooperates readily with them.
  - 17.3.3.4 Athlete is businesslike, yet friendly and courteous, while maintaining sportsmanlike conduct towards officials and other competitors.
- 17.4 **Faults**
  - 17.4.1 Poorly groomed, trimmed horse
  - 17.4.2 Improper position of exhibitor during inspection or while leading the horse
  - 17.4.3 Changing of hands on lead, continuous holding of chain, lead dragging the ground
  - 17.4.4 Failure to set the horse up squarely for inspection or taking excessive time to do so
  - 17.4.5 Backing or leading crooked
  - 17.4.6 Maneuvers not performed at designated markers
  - 17.4.7 Touching the horse
  - 17.4.8 Severe disobedience

## 18. ENGLISH AND WESTERN EVENTS: GYMKHANA

- 18.1 **General Information**
  - 18.1.1 **Tack**
    - 18.1.1.1 Saddles and bridles as required in Equitation classes.
    - 18.1.1.2 **Prohibited equipment:**
      - 18.1.1.2.1 Lariat or reata
      - 18.1.1.2.2 Hackamores
      - 18.1.1.2.3 Tie-downs





- 18.1.1.2.4 Draw reins
- 18.1.1.2.5 Bosals
- 18.1.1.2.6 Wire, metal or rawhide device as part of leather chin strap
- 18.1.1.2.7 Shoes other than standard horse shoes
- 18.1.2 Execution of Gymkhana Events
  - 18.1.2.1 All events are timed. The winner will be the competitor with the fastest time.
  - 18.1.2.2 Riders are required to start the course inside an enclosed ring and may not start until after all gates are closed and secured. Gates may not be opened until the rider has completed the course and returned to a walk or halt.
  - 18.1.2.3 Each athlete will begin from a running start. Time begins as the horse's nose crosses the starting line.
  - 18.1.2.4 Time is complete when the horse's nose crosses the finish line.
  - 18.1.2.5 A 5 second penalty will be added to the time for each of the following:
    - 18.1.2.5.1 Knocking over a pole or barrel. (An athlete is allowed to touch a pole or barrel with his/her hand with no penalty as long as the pole or barrel stays upright.)
    - 18.1.2.5.2 Each 3 strides over the allotted gait for that division.
  - 18.1.2.6 A disqualification will be assessed for the following:
    - 18.1.2.6.1 Failure to follow the course.
    - 18.1.2.6.2 Failure to cross the start/finish line between markers.
    - 18.1.2.6.3 Failure to have the chin strap on the athlete's helmet properly fastened for the entire time he/she is in the arena.
    - 18.1.2.6.4 Recrossing the start/finish line after completing the course.
    - 18.1.2.6.5 Excessive use of a bat, crop, whip or rope, as determined by the judge.
  - 18.1.2.7 In the event of a tie, there will be a run-off using the same course. The competitor declared the winner in the run-off must re-run the pattern within 5 seconds of his/her original time or the run-off must be held again.
- 18.1.3 Facilities and Set-up
  - 18.1.3.1 Whenever possible, starting line markers or electric timers should be placed against the arena wall.
  - 18.1.3.2 The start/finish line must be clearly marked.
  - 18.1.3.3 The course must be measured exactly.
- 18.1.4 Judges forms—See following pages



**EQ Figure of 8 - Barrel Racing and Pole Bending Judges Form**

Competition: \_\_\_\_\_

Division: \_\_\_\_\_

Date: \_\_\_\_\_

Level: \_\_\_\_\_

Athlete Details	Course	time	Penalty Seconds	Total	Place

**Course: Off the course means disqualification**

Judges Name: \_\_\_\_\_

Judges Signature: \_\_\_\_\_

Revised: October 2016



**Team Relay Judges Form**

Competition: EQ Equestrian Team Relays)

Division: \_\_\_\_\_

Date: \_\_\_\_\_

Level: **BI**

Team Number	Athletes Names and Numbers	Course	Penalty Seconds	Time	Total	Place

Course: Off the course means disqualification

Judges Name: \_\_\_\_\_

Judges Signature: \_\_\_\_\_

Revised October 2016



Event	CS	CI	BS	BI	A
Pole Bending	No	No	No	Yes	Yes

18.2.1 Facilities and Set-up

- 18.2.1.1 There should be one person at the arena who is responsible for moving a pole which is knocked down. So as not to disturb or interfere with the rider, that person should wait until the rider is a long distance away and then move the pole quickly.
- 18.2.1.2 The pole bending pattern is to be run around 6 poles set in a straight line.
- 18.2.1.3 Each pole is to be 6.4m (21') apart. The first pole should be 6.4m (21') from the start line.
- 18.2.1.4 Poles should be set on top of the ground at a minimum of 1.83m (6') in height. The base can be no larger than 37cm (14") in diameter.

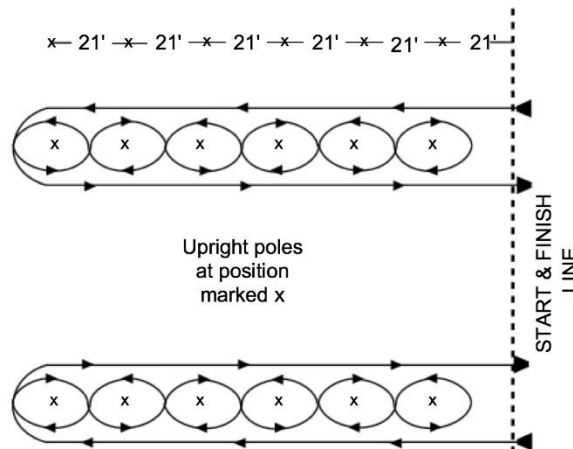

- 18.2.2 Execution of the course: A horse may start either to the right or to the left of the first pole and then run the remainder of the pattern accordingly. These instructions are written for a horse starting to the right of the first pole.
  - 18.2.2.1 At the signal from the starter, the athlete will:
    - 18.2.2.1.1 Run down the right side of the poles to the last pole in the line.
    - 18.2.2.1.2 Turn the last pole to the left.
    - 18.2.2.1.3 Weave the poles, passing them alternately right to left until reaching the first pole.
    - 18.2.2.1.4 Turn the first pole to the right.
    - 18.2.2.1.5 Weave the poles, passing alternately left then right until reaching the last pole.
    - 18.2.2.1.6 Turn the last pole to the left and run straight down the line of poles and cross the finish line.

18.3 Barrel Racing (Western Only)



Event	CS	CI	BS	BI	A
Barrel Racing	No	No	No	Yes	Yes

18.3.1 Facilities and Set-up

18.3.1.1 Three barrels are set in a triangle, using the following measurements:

18.3.1.1.1 Barrels 1 and 2 are set 27.43m (90') apart and 18.29m (60') from the start/finish line.

18.3.1.1.2 Barrel 3 is set in the center (as the top of a triangle) 32m (105') away from barrels 1 and 2. See layout diagram.

18.3.1.2 If the course is too large for the available space, the pattern should be reduced in increments of 4.57m (15') until it fits into the arena. Remember to leave adequate space between barrels and any obstacles. The distance from Barrel 3 to the finish line need not be reduced by these increments if there is sufficient room for the horse to stop.

18.3.1.3 When measuring the area for the barrel course, remember to leave ample room for horses to complete their turns.

18.3.1.4 Allow at least 13.77m (25') from the start/finish line to the end of the arena.

18.3.1.5 Upright poles should mark the start/finish line.

18.3.1.6 Brightly colored 55 gallon plastic or metal drums may be used.

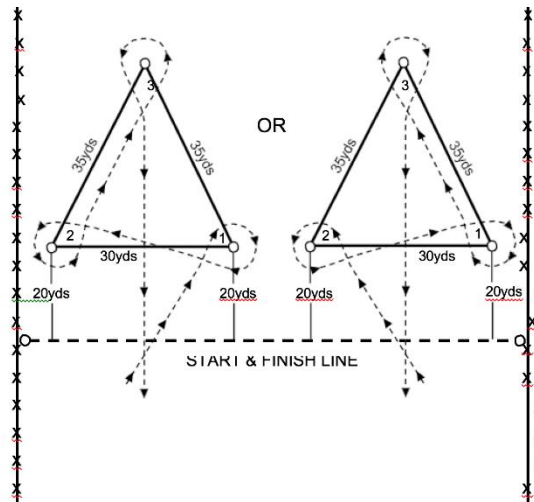

18.3.2 Execution of the course—The barrel course may be run either right or left. The instructions are written right.

18.3.2.1 At a signal from the starter, the athlete will:

18.3.2.1.1 Run barrel number 1, passing to the left of it and completing an approximately 360 degree turn around it.

18.3.2.1.2 Go to barrel number 2, passing to the right of it and completing a slightly more than 360 degree turn around it.

18.3.2.1.3 Go to barrel number 3, passing to the right of it and completing an approximately 360 degree turn around it.



18.3.2.1.4 Then, sprint to the finish line, passing between barrels 1 and 2.

18.4 Figure of 8 (Western Only)

Event	CS	CI	BS	BI	A
Figure of 8	No	No	No	Yes	Yes

18.4.1 Facilities and Set-up

18.4.1.1 The start/finish line should be designated by 2 upright markers 6.1m (20') apart.

18.4.1.1.1 The markers are set 3.5m (10') on each side of the centerline. They must be short enough not to interfere with the electric timer.

18.4.1.2 The first and second poles marking the centerline are 13m (40') from the start/finish line, making them a total of 25m (80') apart.

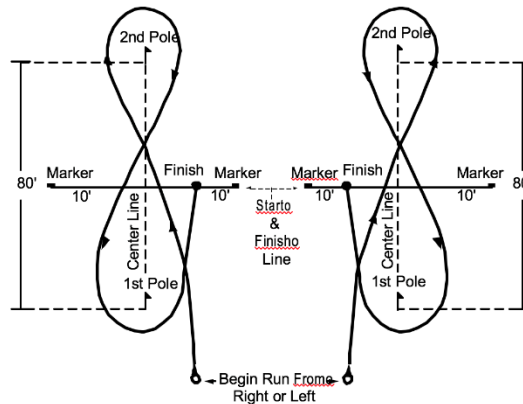

18.4.2 Execution of the course: The course may be run starting at either end. The rider may turn either right or left first, as long as the Figure of 8 is complete. The instructions are written turning right first.

18.4.2.1 At a signal from the starter, the athlete will:

- 18.4.2.1.1 Start by crossing the centerline between the upright markers and then, run to the second pole.
- 18.4.2.1.2 Turn around the second pole to the right.
- 18.4.2.1.3 Run to the first pole.
- 18.4.2.1.4 Turn around the first pole to the left, making the Figure of 8.
- 18.4.2.1.5 Complete the course by running back across the start/finish line.

18.4.2.2 Disqualifications:

- 18.4.2.2.1 Failure of the athlete to cross over the start/finish line between the markers before turning the second pole.
- 18.4.2.2.2 Failure of the athlete to cross over the start/finish line after turning the second pole and going to the first pole.
- 18.4.2.2.3 Knocking over a marker indicating the start/finish line.

18.5 Team Relays



Event	CS	CI	BS	BI	A
Team Relay	Yes	Yes	Yes	Yes	Yes

18.5.1 General Information

- 18.5.1.1 There is no canter at Level A. These riders perform Team Relay in trot.
- 18.5.1.2 Teams in a division must be equal in number with either 2, 3 or 4 riders. The competition management must indicate this in the entry information or the Coaches Handbook.
- 18.5.1.3 If it can be done safely, two teams may compete at the same time.
- 18.5.1.4 The clock is started when the nose of the team’s first mount crosses the starting line.
- 18.5.1.5 The clock is stopped when the nose of the team’s last mount crosses the finish line.
- 18.5.1.6 Batons are prohibited. Riders go when the nose of the previous horse crosses the line.
- 18.5.1.7 Horse handlers, if used, must walk behind the horse's nose. If the horse handler passes the horse’s nose at any time, that rider must make a circle at a walk before continuing.
- 18.5.1.8 Riders entering without a team may draw for partners.

18.5.2 Facilities and Set-up

- 18.5.2.1 Depending on course design, the course should be a total of 30m (98' 5") long for the walk-only division (Level CI/CS) and a total of 50m (164') long for the trot-only division (Level A/BI/BS).
- 18.5.2.2 Suggested relay patterns are to use the barrel, pole or figure 8 stake race or to simply race a straight line.

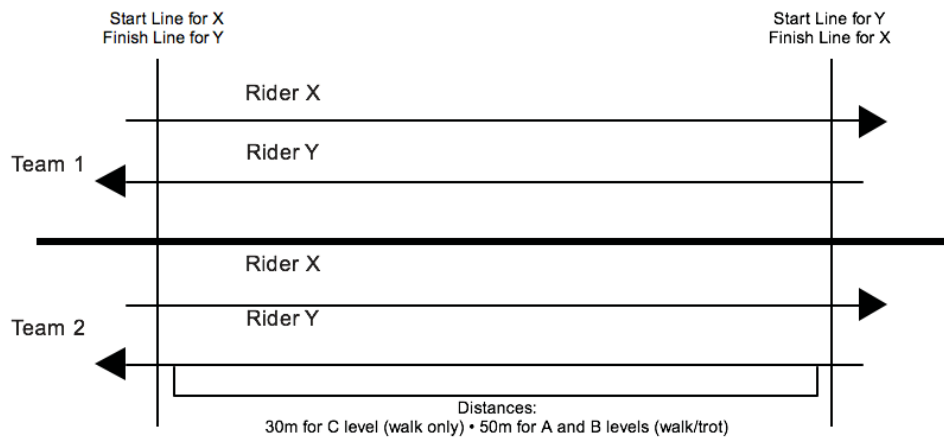

**19. GROUP EVENTS: Drill Teams of 2 & 4**

19.1 General Information

- 19.1.1 The arena will be the small dressage arena with the letters in place as a reference for the riders.



- 19.1.2 English or Western tack style may be used. All rules for bridles and saddles must follow the same guidelines as for the equitation classes.
- 19.1.3 Athletes must wear helmets and boots according to general attire rules.
- 19.1.4 Athletes must adhere to required apparel for safety.
- 19.1.5 Costumes, if worn, must not be a hindrance to the safety of either the athlete or the horse. All costumes should be worn in practice so that the horse and rider can become accustomed to them prior to competition.
- 19.1.6 A reader may call the directions for the drill but is bound by the same rules as those for Dressage and Western Riding.
- 19.2 Judging—200 possible points
  - 19.2.1 Team (Horses and Riders): 35 possible points
    - 19.2.1.1 Costuming = 5
    - 19.2.1.2 Uniformity = 10
    - 19.2.1.3 Appearance = 10
    - 19.2.1.4 Attitude = 10
  - 19.2.2 Performance: 130 possible points
    - 19.2.2.1 Overall Effect = 80
    - 19.2.2.2 Speed = 10
    - 19.2.2.3 Timing = 10
    - 19.2.2.4 Spacing = 10
    - 19.2.2.5 Precision = 10
    - 19.2.2.6 Positioning = 10
  - 19.2.3 Effect: 35 possible points
    - 19.2.3.1 Suitability of Movements = 20
    - 19.2.3.2 Special Effect Music/Props, etc. = 15
- 19.3 Team Composition
  - 19.3.1 A Drill Team may be made up of different divisions of riders, however riders must stay within the qualifications of their divisions within the drill's execution.
    - 19.3.1.1 Division C riders must not be allowed or asked to trot/jog.
    - 19.3.1.2 Division B riders must not be allowed or asked to canter/lope.
    - 19.3.1.3 Division A riders are not required to canter/lope.
- 19.4 Theme—May be portrayed by music and costuming:
  - 19.4.1 Care should be taken in designing costumes to enable the athletes to see and move clearly.
  - 19.4.2 Safety is of utmost importance. No athlete should be attached to either the saddle or the horse.
  - 19.4.3 Costuming the horse should allow for freedom of movement and sight. Hanging or flapping costumes should be avoided.
    - 19.4.3.1 Horses need to practice with the costumes.
    - 19.4.3.2 It would be wise to ride through the whole routine with costumes to allow the horses to see the costumes from all sides.

## 20. GROUP EVENTS: Unified Sports Team Relays

- 20.1 Unified Sports Relay teams may consist of 2 or 4 riders.
- 20.2 During competition, the team must contain 1 Athlete and 1 Partner at all times (2 Athletes and 2 Partners for a 4 person team). Failure to adhere to the required ratio results in a forfeit.
- 20.3 Walk-only and Trot-only divisions will be offered.
- 20.4 See the rules for Team Relays in Gymkhana Events.





**21. GROUP EVENTS: Unified Sports Drill Teams**

- 21.1 Unified Sports Drill Teams may consist of 2 or 4 members.
- 21.2 During competition, the team must contain 1 Athlete and 1Partner at all times (2 Athletes and 2 Partners for a 4 person team). Failure to adhere to the required ratio results in a forfeit.
- 21.3 See the rules for Drill Teams above





Ambulatory Status (underline appropriate)

Wheelchair:    Dependent                      Electric                      Propels Self

Ambulatory: Needs assistance or supervision  
 Independent with:    Walker                      Canes                      Crutches

**Tack/ Equipment Status (underline appropriate)**

Saddle: English              Stock Seat              Other \_\_\_\_\_

Other equipment:

Seat Cover    Handhold    Neckstrap    Adapted Reins              Crop

Dressage Whip              Peacock Stirrups              S-Shaped Stirrups

Devonshire Boots    Waistbelt

Other (please describe) \_\_\_\_\_

*Instructors must bring SEI-ASTM or BHS approved safety stirrups and leathers, and any specially adapted tackle equipment which is required by the rider. Adaptive Equipment must be approved by the Venue Management. All athletes will use the ramp to minimize stress on the horses' backs.*

**Astride Assistance Status – for S (supported) levels**

Place an "X" in the appropriate box.

Assistance Needed	WALK	TROT
HORSE HANDLER		
1 SIDEWALKER		
2 SIDEWALKERS		

**HORSE REQUIREMENTS (underline appropriate)**

*This is very important part so please complete it very carefully with all the details. This information is basic for organizing committee and will help to provide proper horse for the athlete.*

Does the athlete adapt easily to other horses?    Y                      N

Size required \_\_\_\_\_ cm(hands)

Size of barrel:    Narrow                      Normal                      Broad

Gaits which can be handled by the athletes:

Walk:              Steady                      Free                      Moving

Trot:              Very Smooth                      Free                      Moving

**EQUESTRIAN SPORT RULES**



Canter:       Steady                               Free                   Moving

Rein Contact: Light                               Heavy

Other:            Neck Rein                               Direct Rein

Other Information:

---

---

---

*Athletes should be practicing on different mounts to prepare them for the World Games. During the Games, mounting stairs will be used.*

**Career and Accomplishments History (for announcer’s purpose)**

Began riding \_\_\_\_\_

Has instruction: Daily \_\_\_\_\_ Weekly \_\_\_\_\_ Monthly \_\_\_\_\_

Describe the athlete’s Special Olympics equestrian sports competition history.

---

Describe any open equestrian sports competition history.

---

**Medical Status**

Current Special Olympics medical form on file:                               Y                   N

Negative diagnosis for Atlanto-Axial Instability (*for Down syndrome*):   Y                   N

Physician’s Referral Form on file at training sponsor’s office:           Y                   N

List and describe any special health considerations/precautions.

---

---

Does the athlete have any:

Fused joints? (*specify*)

Severe joint limitations or contractures?

Problems with seizures?

List the currently prescribed medications that the athlete is taking?

---

*Please remember to submit this form with the Athlete Registration Form (one for each athlete).*

I certify that I have read, understand and shall abide by the Official Special Olympics Summer Sports Rules (Equestrian Sports) and have entered myself/my athlete in the appropriate level according to this rider Profile and submitted with the Athlete Registration Form.

Signature (*required*) \_\_\_\_\_ Date \_\_\_\_\_



22.1 **Appendix B: Horse Profile**

**HORSE PROFILE**

Name \_\_\_\_\_ Age \_\_\_\_\_

Character \_\_\_\_\_

Height \_\_\_\_\_ Size of barrel: Narrow \_\_\_\_\_ Normal \_\_\_\_\_ Broad \_\_\_\_\_

**Gaits**

Walk: Steady \_\_\_\_\_ Free Moving \_\_\_\_\_

Sitting Trot: Very Smooth \_\_\_\_\_ Free Moving \_\_\_\_\_

Posting Trot: Steady \_\_\_\_\_ Some Springiness \_\_\_\_\_ Freely \_\_\_\_\_

Canter: Steady \_\_\_\_\_ Free Moving \_\_\_\_\_

Jog: Very Smooth \_\_\_\_\_ Free Moving \_\_\_\_\_

Alternate Gait: Very Smooth \_\_\_\_\_ Free Moving \_\_\_\_\_

Rein Contact: Light \_\_\_\_\_ Middle \_\_\_\_\_ Heavy \_\_\_\_\_

**Mounting:**

Regular \_\_\_\_\_ Ramp \_\_\_\_\_ Stairs \_\_\_\_\_ Lift \_\_\_\_\_

**Accept unusual equipment**

(different saddles, stirrups, waistbelt, others): Yes \_\_\_\_\_ No \_\_\_\_\_

Accept handler, side walkers: Yes \_\_\_\_\_ No \_\_\_\_\_

Whip reaction: strong \_\_\_\_\_ normal \_\_\_\_\_ weak \_\_\_\_\_

Used to colourful obstacles: Yes \_\_\_\_\_ No \_\_\_\_\_

**Participated in events:**

Dressage Yes \_\_\_\_\_ No \_\_\_\_\_

Prix Caprilli Yes \_\_\_\_\_ No \_\_\_\_\_

Show Jumping Yes \_\_\_\_\_ No \_\_\_\_\_

Gymkana Yes \_\_\_\_\_ No \_\_\_\_\_

Pony Games Yes \_\_\_\_\_ No \_\_\_\_\_

**Others**

\_\_\_\_\_  
Any vices

\_\_\_\_\_  
Name and Signature

22.2 **Appendix C: English Style Events Glossary**



- 22.2.1 “On the bit”—A horse which is “on the bit” (on the aids) accepts a light contact of the rein with no resistance and is yielding in the jaw and poll to the rider's hand, accepting the aids to move forward into the rein. A horse which is “on the bit” moves with a supple back, shows no resistance in transitions and remains submissive to the rider.
- 22.2.2 Transitions are changes of pace and speed. They should be quickly made yet must be smooth and not abrupt. The horse should remain light in hand, calm and maintain a correct position.
- 22.2.3 Halt—At the halt the horse should stand attentive, motionless and straight, with this weight evenly distributed over all four legs. This is recognized by the pairs of legs being abreast of each other.
- 22.2.4 Diagonals—In the posting trot, the rider should rise as the outside front leg moves forward and sit as the inside front leg moves forward.
- 22.2.5 Change of Lead—In the canter, the inside foreleg should be the leg that appears to be leading the stride. When a rider changes directions, the horse must change the leading leg, or change leads, in one of the following ways:
- 22.2.5.1 Interrupted is a change whereby the horse is brought to the halt, then immediately asked to canter on the new lead.
- 22.2.5.2 Simple is a change whereby the horse is brought to a walk or trot, and then asked to canter on the opposite lead. There should be no more than 3–4 walk or trot strides.
- 22.2.5.3 Flying is a change whereby the horse changes leads during a canter stride. The front and hind legs should change simultaneously.
- 22.2.6 Reverse—A reverse is a change of direction and should be done in the direction away from the rail.
- 22.2.6.1 On a change of direction, the horse should adjust the bend of its body to the curvature of the new line of travel
- 22.2.6.2 The horse should remain supple, following the aids of the rider without changes in pace, rhythm or speed.
- 22.2.6.3 In the posting trot, the rider should change diagonals.
- 22.2.6.4 In the canter, the horse should change leads.
- 22.3 Attire
- 22.3.1 A short, dark colored riding coat.
- 22.3.2 A conservative color, preferably white, riding shirt or Oxford style long or short-sleeved shirt.
- 22.3.3 Tie or choker.
- 22.3.4 Breeches or jodhpurs.
- 22.3.5 Gloves are optional.
- 22.3.6 In case of inclement weather, athletes will be permitted to wear a hat cover and a conservative raincoat.
- 22.3.7 In extreme heat (above 80 degrees), the judges may permit athletes to show without riding coats.
- 22.3.8 Boots with heels.
- 22.3.9 Approved helmet.
- 22.4 Tack
- 22.4.1 An English saddle of any type is required.



22.4.2 One whip no longer than 1 meter (3 feet 3 1/2 inches), including the lash, may be carried. Whips may only be used with permission of the horse owner who must state that the horse is used to the use of a whip. If a rider has poor leg power he must be allocated a free moving horse or one that is used to the whip.

22.5 Stirrups

22.5.1 Safety stirrups are not necessary unless the rider is unable to wear proper boots.

22.5.2 Riders must bring their own safety stirrups and leathers to the competition, unless the event management decides otherwise and specifies that in the Entry information or Coaches' Handbook prior to the competition.

22.6 Bridles

22.6.1 A regular cavesson, a dropped, crossed or a flash noseband is mandatory.

22.6.2 A snaffle bit is required.

22.6.3 All bits must be smooth and solid.

22.6.4 All parts of the bit coming into the horse's mouth (i.e. mouthpiece) may be made of 2 or more metals or material

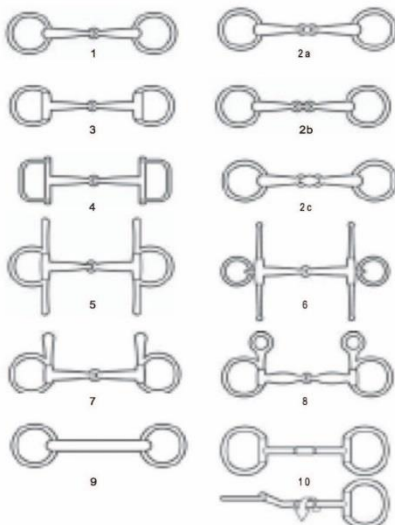

**Various Snaffle Bits:**

1. Loose ring snaffle
2. (a,b,c) Snaffle with jointed mouthpiece where middle piece should be rounded
3. Egg-butt snaffle
4. Racing snaffle D-ring
5. Egg-butt snaffle with cheeks (fulmer)
6. Loose ring snaffle with cheeks
7. Snaffle with upper cheeks only
8. Hanging cheek snaffle
9. Straight bar snaffle
10. Snaffle with rotating mouthpiece

22.7 Rider's Position

22.7.1 The rider should have a workmanlike appearance. The seat and hands should be light and supple. The rider should convey the impression that he/she is in control should any emergency arise.

22.7.2 Basic Position:

- Eyes Up
- Shoulder Back
- Upper body straight, but not stiff or hollow backed
- Toes at an angle best suited to the rider's conformation
- Heels down
- Calf and leg in contact with the horse and slightly behind the girth
- Stirrup on the ball of the foot (must not be tied to the girth)

22.7.3 Hand position



- The hands should be slightly apart, over and in front of the horse's withers, with the knuckles 30 degrees inside the vertical and making a straight line from the horse's mouth to the rider's elbow.
- The method of holding the reins is optional and the excess length of reins may fall on either side.
- All reins must be picked up at the same time.

#### 22.8 Position in Motion:

- 22.8.1 At the walk, sitting trot and canter, the body should be a couple of degrees in front of or on the vertical.
- 22.8.2 During posting trot, the body should be inclined forward or on the vertical.
- 22.8.3 For galloping and jumping, the body should be inclined forward or on the vertical.

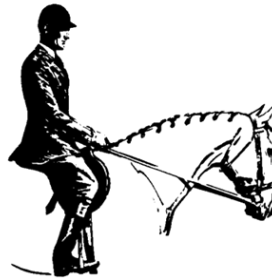

#### 22.9 Appendix D: Western Events Glossary

- 22.9.1 Change of Lead: In the lope, the inside foreleg should be the leg that appears to be leading the stride. When a rider changes directions, the horse must change the leading leg, or change leads, in one of the following ways:
- 22.9.1.1 Interrupted is a change whereby the horse is brought to the halt, then immediately asked to canter on the new lead.
- 22.9.1.2 Simple is a change whereby the horse is brought to walk or trot, and then asked to canter on the opposite lead. There should be no more than 3–4 walk or trot strides.
- 22.9.1.3 Flying is a change whereby the horse changes leads during a canter stride. The front and hind legs should change simultaneously.
- 22.9.2 Jog: A slow trot used in Western disciplines.
- 22.9.3 Lope: A slow canter used in Western disciplines.
- 22.9.4 Reverse: A reverse is a change of direction and should be done in the direction away from the rail.
- 22.9.4.1 On a change of direction, the horse should adjust the bend of its body to the curvature of the new line of travel.
- 22.9.4.2 The horse should remain supple, following the aids of the rider without changes in pace, rhythm or speed.
- 22.9.4.3 In the lope, the horse should change leads.

#### 22.10 Attire

- 22.10.1 Pants/Jeans
- 22.10.2 A long sleeved, collared shirt of a conservative color
- 22.10.3 A belt under loops
- 22.10.4 Neckties, kerchiefs, bolos, chaps and gloves are optional.
- 22.10.5 Chaps are prohibited in all gymkhana events and showmanship classes.
- 22.10.6 On an approved helmet, a western type hat is optional.
- 22.10.7 Boots or shoes with a slick sole and heel are recommended.
- 22.10.8 Spurs are optional

#### 22.11 Tack





22.11.1 Saddles

- 22.11.1.1 The saddle must fit the rider.
- 22.11.1.2 The saddle may be slick or swelled fork and have a high or low cantle.
- 22.11.1.3 Nothing that would prevent the stirrups from hanging freely may be added to or deleted from a standard Western saddle.
- 22.11.1.4 Safety stirrups are required.

22.11.2 Bits and Bridles

- 22.11.2.1 A standard Western bit is defined as having a shank with a maximum length overall of 21cm (8 1/2"). Shanks may be fixed or loose.
- 22.11.2.2 The mouthpiece should consist of a metal bar 75mm (3/8") to 3cm (3/4") in diameter, varying from the straight bar to a jointed mouthpiece.
- 22.11.2.3 Nothing may extend below the horizontal plane of the mouthpiece other than a roller attached to the center of the bit.
- 22.11.2.4 Ports must be no higher than 3 1/2 inches.
- 22.11.2.5 Reins must be attached to each shank.
- 22.11.2.6 A leather chin strap or curb chain may be used, but must be at least 1cm (1/2") in width and lie flat against the jaws of the horse.

Acceptable Shanks

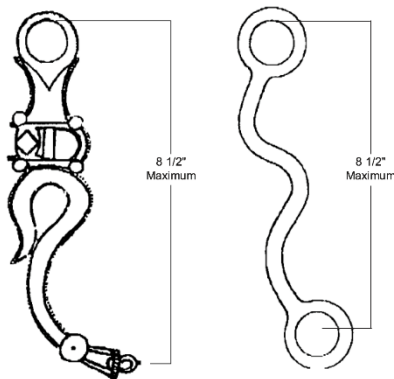

Acceptable Chin Straps



22.12 Rider's Position

- 22.12.1 Riders will be judged on seat, hands, performance of the horse, appointments of the horse and rider, as well as suitability of the horse to the rider.
- 22.12.2 Basic Position:
  - 22.12.2.1 The body should appear comfortable, relaxed and flexible.
  - 22.12.2.2 The rider should sit in the center of the saddle. The legs should hang so that there is a straight vertical line, from the ear, dropping down through the center of the shoulder and hip, touching the back of the heel.
  - 22.12.2.3 The stirrup should be just short enough to allow the heels to be lower than the toes with a slight bend in the knee and the toes directly under the knee.
  - 22.12.2.4 Feet should be placed in the stirrup with the weight on the ball of the foot. Consideration should be given to the width of the stirrups, which vary in Western saddles. If stirrups are wide, the foot may have the appearance of being "home" when, in reality, the weight is being carried properly on the ball of the foot.
  - 22.12.2.5 Arms are held in a relaxed, easy manner with the shoulders back and down. The upper arm should be in a straight line with the body. The arm holding the reins



should be bent at the elbow, forming a straight line from the elbow to the horse's mouth.

22.12.3 Hands:

- 22.12.3.1 Only one hand is to be used for reining, and that hand cannot be changed, with the exception of Trail, when it is permissible to change hands to work an obstacle.
- 22.12.3.2 The reins must be held in one hand, with the exception of horses ridden with a hackamore or snaffle bit, which requires riding with two hands on the reins.
- 22.12.3.3 The rein hand should be above the horn and as near to it as possible. Bracing against the horn or coiled reata is penalized.
- 22.12.3.4 When split reins are used and the ends of the rein fall on the same side as the reining hand, one finger between the reins is permitted. When the ends of split reins are held in the hand not used for reining, no finger between the reins is permitted.
- 22.12.3.5 When using romal reins, no finger between the reins is permitted.
- 22.12.3.6 The position of the hand not being used for reining is optional, but the hand should be kept free of the horse and equipment and held in a relaxed manner straight with the rider's body at all times.
- 22.12.3.7 The rider can hold the romal or the end of split reins to keep them from swinging and to adjust the length of the reins, provided they hold them at least 41cm (16") from the reining hand.

22.12.4 Position in Motion:

- 22.12.4.1 The rider should sit the jog and not post. (Unless otherwise specified in division rules.)
- 22.12.4.2 At the lope, the rider should be close to the saddle.
- 22.12.4.3 All movements of the horse should be governed by the use of imperceptible aids. The shifting of the rider's weight is not desirable.

